



Pump and Motor Sizing Guide



Introduction

Heavy Duty Hydrostatic Transmission

Introduction:

Selection of the proper size pump and motor(s) for your transmission application may require one of two methods. The first method is to calculate the "Power Range" of your vehicle or machine. This method is used when the final gear reduction between the motor and load is unknown or the customer wants assistance to select the final drive ratio (see section I). The second method is used when the final drive ratio is specified by the customer (see section II,2).

The following is a list of the commonly encountered vehicle and machine performance requirements that are specified:

- 1) Tractive effort and vehicle speed in the normal working gear range. Some vehicles may have 2, 3, or more operating gear ranges.
- 2) Drawbar pull and vehicle speed in the normal working gear range.
- 3) Gradeability and vehicle speed in the normal working gear range.
- 4) Line pull and line speed for a winch.
- 5) Shaft torque and shaft speed at the output shaft of a gearbox.

The above factors must all be maximum in value and taken at maximum applied input power.

I. Power Range Calculations

1. When maximum vehicle tractive effort and maximum vehicle speed in the normal working range are specified, the vehicle power range can be calculated using the following formula: (See Fig. 2a)

$$PR_v = (TE)(Vs)/(C_1)(Er), \text{ where:}$$

PR_v = Vehicle Power Range

TE = Maximum vehicle tractive effort in the normal working range (lbs or Newtons)

Vs = Maximum vehicle speed in mph or kph

C₁ = A constant to convert to units of horsepower or Kilowatts

C₁=375 to convert to hp and C₁=3600 to convert to Kw

Er = Final drive ratio efficiency

2. When maximum vehicle drawbar pull and maximum vehicle speed in the working range are specified, the vehicle Power Range can be found from the following formula:

$$PR_v = (DBP+RR)(Vs)/(C_1)(Er), \text{ where:}$$

RR = (r)(GVW)

DBP = Maximum vehicle drawbar pull (lbs or Newtons)

RR = Vehicle rolling resistance (lbs or Newtons)

ρ = Coefficient of rolling resistance

GVW = Gross vehicle weight (lbs or Newtons)

Note: Values of r can be found in universally accepted tables of coefficients of rolling resistance for various ground contacting apparatus and ground conditions, such as rubber tires or crawler tracks. See Table 7, page 11 for representative values.

3. If the maximum vehicle gradeability and maximum vehicle speed in the working range are specified, the vehicle Power Range can be computed from the following formula: (See Fig. 2b)

$$PR_v = (TE)(Vs)/(C_1)(Er), \text{ where:}$$

TE = (GVW)(sin q)+(RR)(cos q)

q = Tan⁻¹(G/100) or = Arctan (G/100)

TE = Vehicle tractive effort required to ascend the grade

q = Grade Angle (degrees)

G = Gradeability (percent)

4. If tractive effort, drawbar pull, or gradeability cannot be provided, the Power Range must be found from knowledge of the vehicle operation. Eaton recommends that **all** vehicle propel applications be sized such that wheel or track slip be attainable (exceptions **may** include an asphalt compactor or certain personnel carriers). (See Fig.2a)

$$PR_v = (TE)(Vs)/C_1(Er), \text{ where:}$$

TE = (Wda)(μ)

TE = Vehicle tractive effort to slip the drive wheels (or track)

Wda = Maximum weight on drive wheels (or track)

μ = Coefficient of traction (friction or adhesion) between wheels (or track) and ground (use the maximum value for vehicle operating conditions)

Note: Values for μ can be found from universally accepted tables of coefficients of traction for various types of ground contacting apparatus and ground conditions. See Table 8, page 11 for representative values.

5. If output shaft torque and output shaft speed are known, the Power Range for a machine can be found by the following formula: (See Fig. 1)

$$PR_m = (Ts)(Ns)/C_2(Er), \text{ where:}$$

PR_m = Machine Power Range

Ts = Maximum shaft torque (lb-in or N-m)

Ns = Maximum shaft speed (RPM)

C₂ = A constant to convert to units of power.

C₂ = 63025 to convert to HP and 9549,3 to convert to Kw.

Note: Be sure to use maximum locked rotor torque when replacing electric motors.

- When line pull and line speed in the normal working range are known, the Power Range for a winch application can be found using the following formula: (See Fig 3)

$$PR_w = (LP)(LS)/C_3(E_r), \text{ where:}$$

PR_w = Winch Power Range

LP = Line pull (lbs or Newtons)

LS = Line speed (ft/min or meters/sec)

C₃ = A constant to convert to units of power

C₃ = 33000 to convert to HP and 1000 to convert to Kw.

E_r = Final drive ratio efficiency

II. Motor Selection

- The first component selected in a hydrostatic transmission is the motor. Now select the Eaton heavy duty motor with a working Power Range rating equal to or greater than the Power Range calculated for the vehicle, machine, winch, etc. See Table 2 or 5, page 9 or 11 for the motor selection.

If the motor is to be applied at less than rated speed or pressure, the value used for PR_{em} must be reduced proportionately. If the engine overspeed factor is other than the factor used (1.2), then the PR_{em} must also be altered proportionately to adequately account for the correct value of engine overspeed. See the formula for PR_{em} for Table 2 or Table 5

- If the customer specifies the final drive ratio, select the motor based on the torque necessary to give the desired tractive effort, drawbar pull, gradeability, shaft torque or winch drum torque.

- Calculate the maximum output torque, or winch drum torque.

For vehicle propel:

$$T_w = (TE)(LR)$$

T_w = Wheel (ie: axle torque N-m or lb-in)

LR = Loaded radius of the drive wheel (inches or meters)

For winch drive:

$$T_d = (L.P.)(D.R.\text{eff})$$

$$D.R.\text{eff} = [D.R. + (.5)(d.c.) + (nc - 1)(d.c.)]$$

d.c. = Cable diameter (inches or mm)

N = Number of wraps of the cable on the drum

D.R.eff = effective drum radius of the winch
(m or in)

T_d = Winch drum torque (N-m or lb in)

L.P. = Line (or cable) pull (Newtons or pounds)

- Calculate the necessary motor torque:

For vehicle propel:

T_m = T_w/(FDR)(E_r), where:

T_m = Motor torque necessary to provide maximum vehicle tractive effort, shaft torque or line pull (lb-in or N-m)

FDR = Final drive ratio

E_r = Final drive ratio efficiency

For gear box shaft drive:

$$T_m = \frac{T_s}{(FDR)(E_r)}$$

For winch drive:

$$T_m = \frac{T_d}{(FDR)(E_r)}$$

- Select a motor having an output torque rating equal to or greater than the torque calculated in step B above. See table 2 or 5 for motor torque ratings. Select the motor based on the torque ratings at 414 bar [6000 PSI] unless a lower pressure must be used based on hose and fitting considerations.

III. Final Drive Ratio Selection

Final drive ratios should always be selected based on attaining the vehicle tractive effort, shaft torque or line pull specifications.

- Calculate the maximum drive wheel torque (axle torque)

For vehicle propel:

$$T_w = (TE)(LR)$$

For winch drive:

$$T_d = (L.P.)(D.R.\text{eff})$$

- Calculate the maximum hydraulic motor torque for the motor selected from Section II or listed in table 2 or 5.

$$T_m = (D_m)(P)(E_{tm})/2\pi \quad (\text{lb-in})$$

or $T_m = (D_m)(P)(E_{tm})/20\pi \quad (\text{N-m})$, where:

T_m = Motor torque (lb-in or N-m)

D_m = Motor displacement (in³/rev or cm³/rev)
 P = System pressure (bar or PSI)
 E_{tm} = Motor torque efficiency (use .95)

C. Calculate the final drive ratio.

For vehicle Propel:

$$FDR = T_w / (T_m)(E_r)$$

For gear shaft drive:

$$FDR = \frac{T_s}{(T_m)(E_r)}$$

For winch drive:

$$FDR = \frac{T_d}{(T_m)(E_r)}$$

where: FDR = Final drive ratio

Note: Typical final drive efficiencies range from 85 to 90 percent. Straight spur gears have an efficiency loss of approximately 2% per mesh. Bevel gears have a 7% to 12% loss in efficiency per mesh.

D. Final drive ratio calculations for multispeed final drives used for vehicle propel applications.

$FDR_1 = T_w / (T_m)(E_r)$, where:

FDR_1 = Final drive ratio in first gear

also $K = P_{Rem} / H_{Pe}$

and $FDR_2 = (FDR_1)(1.05) / K$

and $FDR_3 = (FDR_2)(1.05) / K$

and $FDR_4 = (FDR_3)(1.05) / K$

Where K = ratio of the Power Range factor of the Eaton motor selected to normal applied engine power.

Note: The above multispeed ratio calculations are based on providing gear ratios that will give uniform increments in output torque and output speed. These calculations will provide a five percent (5%) overlap between successive gear changes. These calculations are only a guide to assist selecting commercially available multispeed gear boxes.

IV. Pump Selection

1. Pump selection depends on several factors, including the following:

A Engine full load governed speed.

B Maximum engine speed during dynamic braking conditions will be in excess of the full load speed when the engine is back driven by an overrunning load through the transmission.

C Availability of a gear box to increase or decrease the pump speed from the engine.

D Reversal of pump and motor identity during periods of dynamic braking.

2. Determine the motor speed necessary to provide the specified output speed.

For vehicle propel:

$$N_m = (V_s)(FDR)(m) / LR, \text{ where}$$

N_m = Necessary loaded motor speed (RPM)

m = Conversion factor to convert to units of miles per hour or kilometers per hour

$m = 168$ for MPH and 2.65 for kph

For gear box shaft drive:

$$N_m = (N_s)(FDR)$$

N_s = Output speed of gear box drive shaft

For winch drive:

$$N_m = \frac{(L.S.)(FDR)(C_2)}{(D.R. \text{ eff})(C_3)}$$

D.R. eff must be at its minimum value

3. Calculate the pump displacement necessary to provide the calculated motor speed.

$N_p = (N_e)(IDR)$, where:

N_p = Pump input speed (RPM)

N_e = Full load governed engine speed (RPM)

IDR = Input drive ratio between pump and engine

$D_p = (N_m n)(D_m) / (N_p)(E_{vp})(E_{vm})$, where:

D_p = Pump displacement (in³/rev or cm³/rev)

$N_m n$ = Necessary loaded motor speed (RPM)

D_m = Motor displacement (in³/rev or cm³/rev)

N_p = Pump input speed (RPM)

E_{vp} = Pump volumetric efficiency

E_{vm} = Motor volumetric efficiency

Note: Pump and motor volumetric efficiency can be found from the performance curves or by using 96% and 97%, respectively, for these efficiency values. Use 94% for a variable displacement motor.

4. If no variation is possible in the input drive ratio to the pump, select the pump with a displacement nearest to the displacement calculated in part 3 of Section IV. See table 3 or 6, page 13 or 14

- If the input drive ratio can be altered, select a pump having a displacement equal to that of the motor and calculate the input drive ratio as follows:

$$IDR = (Nm_n)(Dm)/(Ne)(Dp)(Evp)(Evm)$$

where IDR = Input drive ratio

Nm_n = Necessary loaded motor speed (RPM) (from Part 2 of Section IV)

Dm = Motor displacement (in³/rev or cm³/rev) (Remember to use the minimum displacement setting for variable motors.)

Evm = Motor volumetric efficiency (use .97 for a fixed motor and .94 for a variable motor)

Evp = Pump volumetric efficiency (use .96)

Dp = Pump displacement (in³/rev or cm³/rev)

Ne = Full load governed engine speed (RPM)

V. Overspeed Calculations

With the pump, motor, final drive ratio, and input drive ratio determined, check the transmission performance to verify that motor and pump overspeed conditions cannot occur during overrunning loads.

- Calculate the maximum motor speed and compare to the maximum rated speed listed in Table 2. **Remember to use the minimum displacement setting for variable motors.**

$$Nm_{max} = (Dp)(Ne)(Eos)(IDR)/(Dm)(Evp)(Evm)$$

where Eos = Ne max/Ne (RPM)

Nm max = Maximum engine speed during an overdriving condition (RPM)

$$Nm_{max} \leq Nmr$$

where Nmr = Maximum rated speed of the motor (RPM) from tables 2 and 5.

- Check for pump overspeed.

$$Np_{max} = (Ne)(Eos)(IDR)$$

where Np max = Maximum pump speed (RPM)

$$Np_{max} \leq Npr$$

where Npr = Maximum rated speed of the pump (RPM) from Tables 3 or 6.

- If an overspeed condition exists, the system must be revised. Recheck all calculations and review the vehicle or machine specifications.

VI. Power Limiting Pressure

A check of the power limiting pressure of the pump must finally be made.

- Calculate the available input torque to the pump.

$$Tp = (Pi)(C_2)(Eir)/(NE)(IDR)$$

Tp = Input torque to the pump (N-m or lb-in)

(Pi) = Rated input power (KW or hp)

Eir = Input drive ratio efficiency

- Calculate the power limiting pressure of the pump using the value calculated for Tip above.

$$P = (Tp)(2\pi)(Etp)/(Dp) \quad (\text{PSI})$$

$$\text{or } P = (Tp)(20\pi)(Etp)/(Dp) \quad (\text{bar})$$

where P = Power limiting pressure (PSI or bar)

Etp = Pump torque efficiency (use .95)

VII. Pressure Override Control/Power Limiter Specification Criteria

- When the power limiting pressure of the pump (as calculated in Section VI) exceeds 3500 PSI or 240 bar, it is normally advisable to use a pressure override or power limiter control on the pump to prevent extended operation of the transmission at conditions of high pressure relief valve settings. Certain types of vehicles such as forage harvesters, tree harvesters and combines have large engines that normally supply the largest percentage of their power to drive the auxiliary drives rather than the propulsion drive. However, the load conditions can exist when all of the engine power is available to the hydrostatic propulsion drive.

During these load conditions, the transmission may be required to provide power to propel the vehicle, which could result in reaching system relief valve pressures.

During these conditions it is far better to provide a control means (such as a pressure override or power limiter) that will destroke the pump rather than relieve large amounts of flow (resulting in extremely high fluid temperatures) over the high pressure relief valves. During pressure override or power limiter operation, the transmission will maintain torque to the wheels at a speed corresponding to the load conditions.

- If the application specifies that high inertia loads are to be accelerated or the potential exists for the operator to work the machine in a higher speed ratio than that intended for the working range, a pressure override or power limiter control will be necessary.

A typical vehicle having high inertia loads to accelerate is a mine locomotive. A typical vehicle that may be worked in a high speed range rather than the working range is a farm tractor.

- When the transmission is applied on drives that are unattended for prolonged periods, a pressure override or power limiter control should be used on the pump. Drives that are in this application category include conveyor drives and elevator drives on self-loading scrapers.

VIII. Charge Pump Displacement Calculations and Selection

Charge Pump Displacement for Systems with Eaton Heavy Duty Pumps and Motors:

$$D_{cp} = 0.156(n_p \times D_p + n_m \times D_m) / 2$$

D_{cp} = Charge Pump Displacement
 n_p = Number of Pumps
 n_m = Number of Motors

Charge Pump Displacement for Systems with Eaton Heavy Duty Pumps and **non- Eaton** Heavy Duty Motors:

$$D_{cp} = 0.156D_p + (1000 \times (M_{leakage}) / N_p)$$

D_{cp} = Charge Pump Displacement (cm³/rev)
 $M_{leakage}$ = Maximum Leakage of Non - Eaton Motor(s) [lpm]
 N_p = Pump input speed

Charge Pump Displacement for Systems with Eaton Heavy Duty Pumps and **non- Eaton** Heavy Duty Motors:

$$D_{cp} = 0.156D_p + (231 \times (M_{leakage}) / N_p)$$

D_{cp} = Charge Pump Displacement (in³/rev)
 $M_{leakage}$ = Maximum Leakage of Non - Eaton Motor(s) [gpm]
 N_p = Pump input speed

Minimum Charge Pump Displacement for Single Pump/Motor Applications

Pump/Motor Model	Charge Pump
• 3321/3331	• 13,9 cm ³ /rev
• 3921/3331	• 13,9 cm ³ /rev
• 4621/4631	• 13,9 cm ³ /rev
• 5421/5431	• 13,9 cm ³ /rev
• 6421/6431	• 17,4 cm ³ /rev
• 7220/7630	• 21,0 cm ³ /rev

Minimum Charge Pump Displacement for Single Pump/Motor Applications

Pump/Motor Model	Charge Pump
• 3321/3331	• 0.85 cm ³ /rev
• 3921/3331	• 0.85 cm ³ /rev
• 4621/4631	• 0.85 cm ³ /rev
• 5421/5431	• 0.85 cm ³ /rev
• 6421/6431	• 1.06 cm ³ /rev
• 7220/7630	• 1.28 cm ³ /rev

Minimum Charge Pump Displacement for Transit Mixer Applications

Pump Model	Charge Pump
• 3321	• 17,4 in ³ /rev
• 3921	• 17,4 in ³ /rev
• 4621	• 21,0 in ³ /rev
• 5421	• 21,0 in ³ /rev
• 6421	• 27,9 in ³ /rev

Minimum Charge Pump Displacement for Transit Mixer Applications

Pump Model	Charge Pump
• 3321	• 1.06 in ³ /rev
• 3921	• 1.06 in ³ /rev
• 4621	• 1.28 in ³ /rev
• 5421	• 1.28 in ³ /rev
• 6421	• 1.70 in ³ /rev

IX. Gradeability Calculation (reference)

To find the percent grade that a vehicle will ascend after the tractive effort, gross vehicle weight, and coefficient of rolling resistance are known, the following formulas are used:

$$G = 100 \tan \Theta$$

where $\Theta = \sin^{-1}(1/\sqrt{1+r^2}) + \sin^{-1}(T.E./GVW\sqrt{1+r^2}) - 90^\circ$

G = Gradeability (percent)

These formulas may be used after the transmission has been selected. They are provided as a helpful means to determine vehicle gradeability when the transmission was selected from data specifying performance other than gradeability.

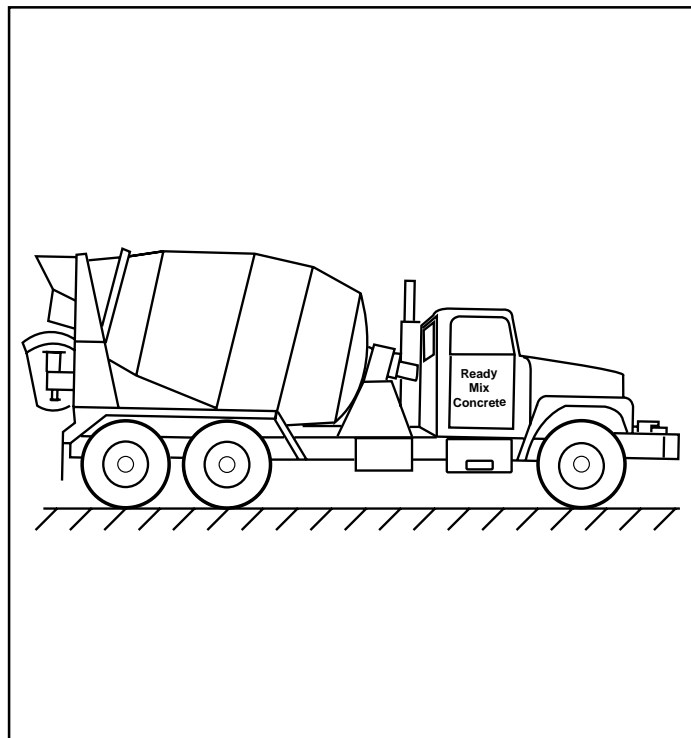
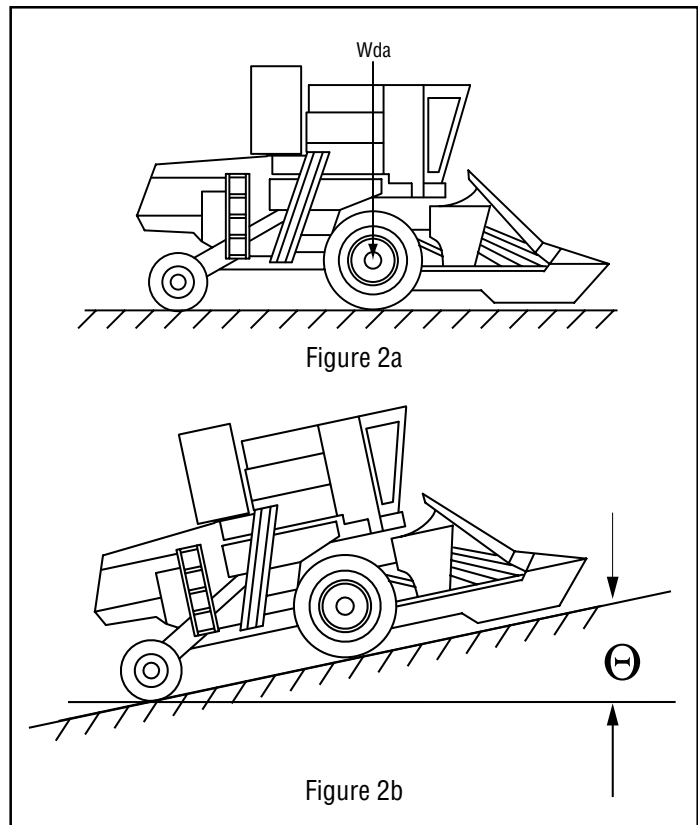

Figure 1

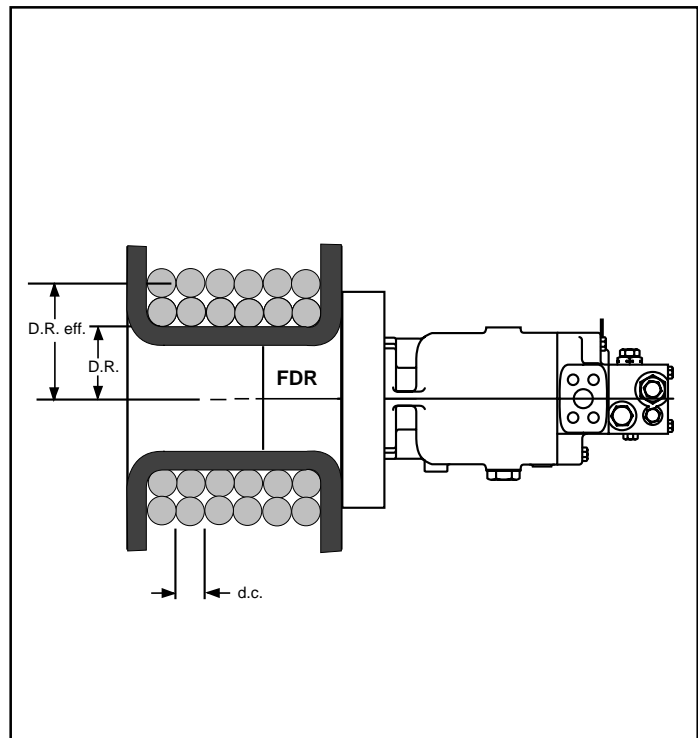

Figure 3

Design Parameters

Table 1

Design Parameters – Metric Units						
Model	Disp. (cm ³ /rev)	Max. Shaft Speed @ 18° (RPM)	Max. Shaft Speed @ 10° or less (RPM)	Theoretical Performance		
				Torque @ 414 bar (N-m)	Fixed Motor Power Range (Kw)	Variable Motor Power Range (Kw)
33*	54,34	4510*	5385	358	169	202
39	63,66	4165	5385	419	183	236
46	75,28	4165	5385	496	216	280
54	89,13	3720	4810	587	229	296
64	105,4	3720	4810	694	270	350
76	124,8	2775	3425	822	239	295

Table 2

Motor Working Performance – Metric Units						
Model	Disp. (cm ³ /rev)	Max. Shaft Speed @ 18° (RPM)	Output Torque @ 414 bar (N-m)	Fixed Motor Power Range (Kw)	Max. Shaft Speed @ 10° or less (RPM)	Variable Motor Power Range (Kw)
33*	54,34	4510*	340	116	5385	138
39	63,66	4165	398	125	5385	162
46	75,28	4165	471	148	5385	192
54	89,16	3720	557	157	4810	203
64	105,4	3720	659	186	4810	240
76	124,8	2775	781	164	3425	202

$$P.R. em = \frac{(Tm)(Nm)(Evm)^2 (Evp)^2}{(9549.3)(Eos)}$$

where Tm = Actual motor output torque @ 414 bar and maximum displacement from Table 2 above.

Nm = Maximum rated motor speed at 18° for a fixed motor (MF) or at 10° or less for a variable motor (MV).

*Model 33 is a 15.5° unit.

Evm = Volumetric efficiency of the motor (use .97 for a fixed motor and .94 for a variable motor).

Evp = Volumetric efficiency of the pump (use .96)

9549.3 = Constant to convert to units of Kilowatts.

Eos = Engine overspeed factor (use 1.2)

Table 3

Pump Working Performance – Metric Units						
Model	Disp. (cm ³ /rev)	Max. Shaft Speed @ 18K (RPM)	Output Flow @ 240 bar (l/m)	Input Torque		
				@ 170 bar (N-m)	@ 210 bar (N-m)	@ 240 bar (N-m)
33*	54,34	4510*	235	155	191	218
39	63,66	4165	255	181	224	256
46	75,28	4165	301	214	265	303
54	89,16	3720	318	254	314	358
64	105,4	3720	376	300	371	424
76	124,8	2775	332	355	439	502

$$T_p = \frac{(D_p)(P)}{(2\pi)(E_{tp})}$$

where T_p = Input torque to the pump (neglecting charge pump) (Nm)

D_p = Pump displacement (cm³/rev)

P = Differential pressure at the pump (bar)

2π = Factor to convert revolutions to radians

E_{tp} = Torque efficiency of the pump (use .95)

where Q_p = Pump flow (l/m)

D_p = Pump displacement (cm³/rev)

N_{pr} = Rated speed of pump. *Model 33 is 15.5°

E_{vp} = Pump volumetric efficiency (use .96)

Table 4

Design Parameters – U.S. Units						
Model	Disp. (in ³ /rev)	Max. Shaft Speed @ 18° (RPM)	Max. Shaft Speed @ 10° or less (RPM)	Theoretical Performance		
				Torque @ 6000 PSI (lb-in)	Fixed Motor Power Range (Hp)	Variable Motor Power Range (Hp)
33*	3.316	4510*	5385	3167	227	271
39	3.885	4165	5385	3710	245	317
46	4.594	4165	5385	4387	290	375
54	5.439	3720	4810	5194	307	396
64	6.431	3720	4810	6141	362	469
76	7.615	2775	3425	7272	320	395

Table 5

Motor Working Performance – U.S. Units						
Model	Disp. (in ³ /rev)	Max. Shaft Speed @ 18° (RPM)	Output Torque @ 6000 PSI (lb-in)	Fixed Motor Power Range (Hp)	Max. Shaft Speed @ 10° or less (RPM)	Variable Motor Power Range (Hp)
33*	3.316	4510*	3008	156	5385	174
39	3.885	4165	3524	168	5385	204
46	4.594	4165	4168	199	5385	242
54	5.439	3720	4934	210	4810	256
64	6.431	3720	5834	249	4810	302
76	7.615	2775	6908	220	3425	255

$$P.R. \text{ em} = \frac{(T_m)(N_m)(E_{vm})^2 (E_{vp})^2}{(63025)(E_{os})}$$

where T_m = Actual motor output torque @ 6000 PSI and maximum displacement from Table 5 above.

N_m = Maximum rated motor speed at 18° for a fixed motor (MF) or at 10° or less for a variable motor (MV). *Model 33 is a 15.5° unit.

E_{vm} = Volumetric efficiency of the motor (use .97 for a fixed motor and .94 for a variable motor).

E_{vp} = Volumetric efficiency of the pump (use .96)

63025 = Constant to convert to units of Kilowatts.

E_{os} = Engine overspeed factor (use 1.2)

Table 6

Pump Working Performance – U.S. Units						
Model	Disp. (cm ³ /rev)	Max. Shaft Speed @ 18° (RPM)	Output Flow @ 3500 PSI (GPM)	Input Torque		
				@ 2500 PSI (lb-in)	@ 3000 PSI (lb-in)	@ 3500 PSI (lb-in)
33*	3.316	4510*	62.2	389	1667	1945
39	3.885	4165	67.2	1627	1952	2278
46	4.594	4165	79.5	1924	2309	2694
54	5.439	3720	84.1	2278	2734	3189
64	6.431	3720	99.4	2693	3232	3771
76	7.615	2775	87.8	3189	3827	4465

$$T_p = \frac{(D_p)(P)}{(2\pi)(E_{tp})}$$

where T_p = Input torque to the pump (neglecting charge pump) (in.lb.)

D_p = Pump displacement (in³/rev)

P = Differential pressure at the pump (PSI)

2π = Factor to convert revolutions to radians

E_{tp} = Torque efficiency of the pump (use .95)

$$Q_p = \frac{(D_p)(N_{pr})(E_{vp})}{231}$$

where Q_p = Pump flow (GPM)

D_p = Pump displacement (in³/rev)

N_{pr} = Rated speed of pump. *Model 33 is 15.5°

E_{vp} = Pump volumetric efficiency (use .96)

231 = Constant to convert to units of gallons

Table 7

Surface	Coefficient of Rolling Resistance (ρ)	
	Rubber Tire Vehicles	Crawler Vehicles
Concrete	.01 to .02	.03 to .04
Asphalt	.012 to 0.22	.03 to .04
Macadam	.015 to .037	.035 to .045
Smooth Dirt/Gravel Roads	.025 to .04	.025 to .05
Unplowed Earth	.04 to .075	.04 to .08
Loose Earth	.05 to .09	.06 to .08
Loose Sand or Gravel	.10 to .14	.10 to .12
Mud - Firm Base	.04 to .06	.05 to .09
Mud - Soft Base	.15 to .18	.10 to .13
Steel	Steel Wheel (Railroad) Vehicles .004	

Table 8

Surface	Coefficient of Traction (μ)	
	Rubber Tire Vehicles	Crawler Vehicles
Concrete	.8 to 1.0	.45
Asphalt	.8 to 1.0	.5
Macadam	.7 to .9	.55
Dry Clay Loam	.5 to .7	.9 to 1.0
Wet Clay Loam	.4 to .5	.7
Damp Sand or Gravel	.3 to .4	.35
Loose Sand	.2 to .35	.3
Firm Earth	.5 to .6	.9 to 1.0
Loose Earth	.4 to .5	.6
Grass	.4	N/A
Steel	Steel Wheel (Railroad) Vehicles .15 to .25	

* According to the University of Nebraska (USA), the rolling resistance for crawler tractors is arrived at using the following formula:

$$RR = 1.99 (GVW)^{.673} \text{ on firm earth}$$

Table 9

Swash-plate Angle	Model 33 *	Model 39 *	Model 46 *	Model 54 *	Model 64 *	Model 76 *
	1°	3,420 [2.087]	3,429 [2.087]	4,044 [2.468]	4,788 [2.922]	6,661 [3.454]
2°	6,842 [4.175]	6,482 [4.175]	8,091 [4.937]	9,579 [5.845]	11,33 [6.911]	13,41 [8.184]
3°	10,27 [6.266]	10,27 [6.266]	12,14 [7.410]	14,38 [8.773]	17,00 [10.37]	20,13 [12.28]
4°	13,70 [8.361]	13,70 [8.361]	16,20 [9.886]	19,18 [11.70]	22,68 [13.84]	26,86 [16.39]
5°	17,14 [10.46]	17,14 [12.37]	20,27 [12.37]	24,00 [14.64]	28,38 [17.32]	33,60 [20.50]
6°	20,59 [12.57]	20,59 [12.57]	24,35 [14.86]	28,83 [17.59]	34,09 [20.80]	40,37 [24.63]
7°	24,06 [14.68]	24,06 [14.68]	28,45 [17.36]	33,68 [20.55]	39,82 [24.30]	47,16 [28.78]
8°	27,54 [16.80]	27,54 [16.80]	32,56 [19.87]	38,55 [23.52]	45,58 [27.82]	53,98 [32.94]
9°	31,03 [18.94]	31,03 [18.94]	36,70 [22.39]	43,45 [26.51]	51,37 [31.35]	60,83 [37.12]
10°	34,55 [21.08]	34,55 [21.08]	40,85 [24.93]	48,37 [29.52]	57,19 [34.90]	67,72 [41.32]
11°	38,09 [23.24]	38,09 [23.24]	45,04 [27.48]	53,32 [32.54]	63,05 [38.47]	74,65 [45.56]
12°	41,65 [25.41]	41,65 [25.41]	49,25 [30.05]	58,31 [35.58]	68,94 [42.07]	81,63 [49.81]
13°	45,24 [27.60]	45,24 [27.60]	53,49 [32.64]	63,33 [38.65]	74,88 [45.69]	88,67 [54.11]
14°	48,85 [29.81]	48,85 [29.81]	57,77 [35.25]	68,39 [41.74]	80,88 [49.35]	95,76 [58.43]
15°	52,50 [32.04]	52,50 [32.04]	62,08 [37.88]	73,50 [44.85]	86,91 [53.03]	102,9 [62.80]
15.5°	54,34 [3.316]					
16°		56,18 [3.428]	66,44 [4.054]	78,66 [4.800]	93,00 [5.675]	110,1 [6.720]
17°		59,90 [3.655]	70,84 [4.322]	83,87 [5.118]	99,16 [6.031]	117,4 [7.165]
18°		63,60 [3.885]	75,28 [4.594]	89,13 [5.439]	105,4 [6.431]	127,8 [7.615]

* The maximum swashplate angle on Model 33 variable pumps and motors is 15.5°, which is 54,34 cm³/rev [3.316 in³/rev]

Pump and Motor Performance

Pump Performance 15.5 Degrees Swash Angle Model 3321 1800 RPM

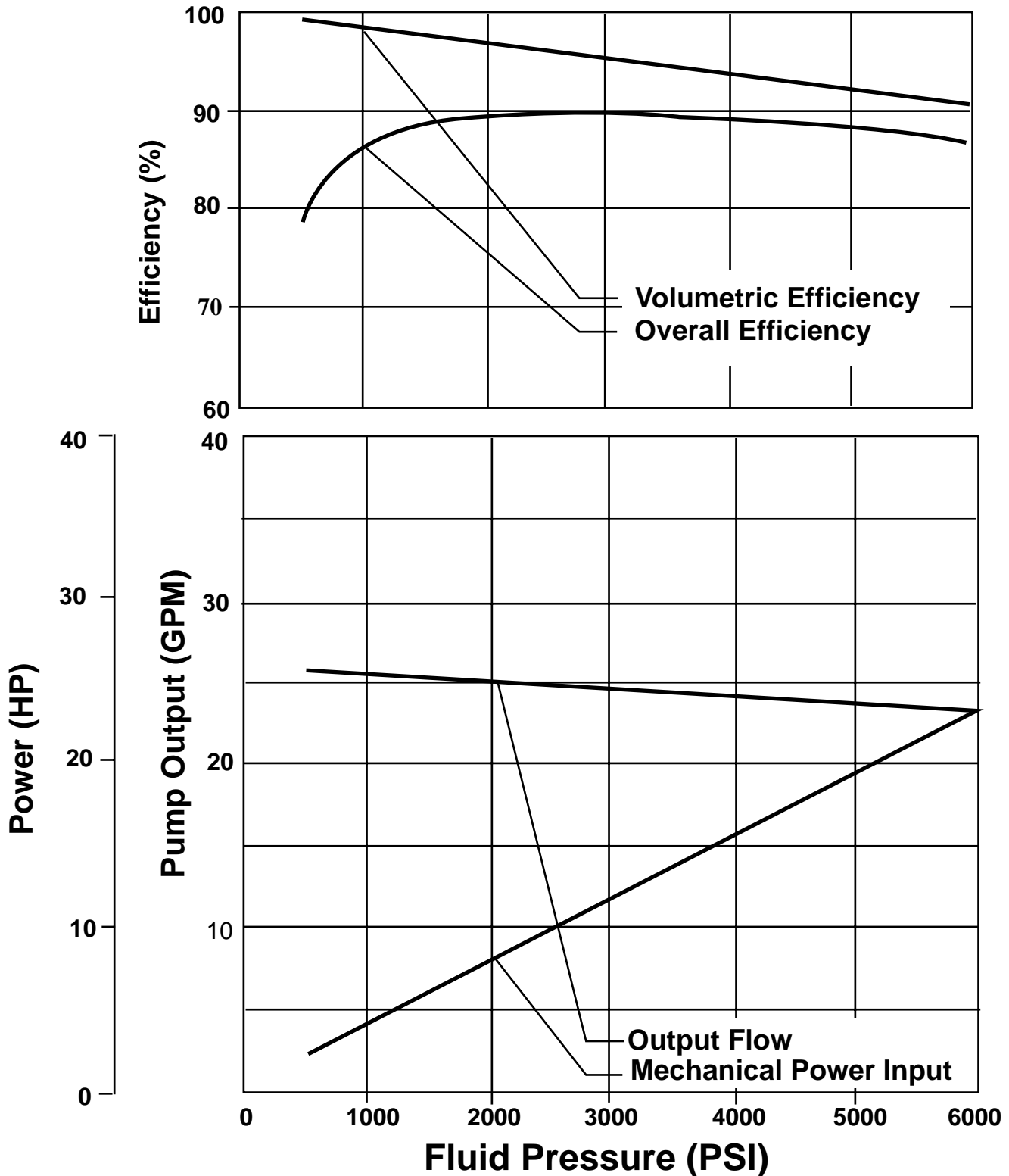

These curves DO NOT reflect charge pump losses

Pump Performance 18 Degrees Swash Angle Model 3921 1800 RPM

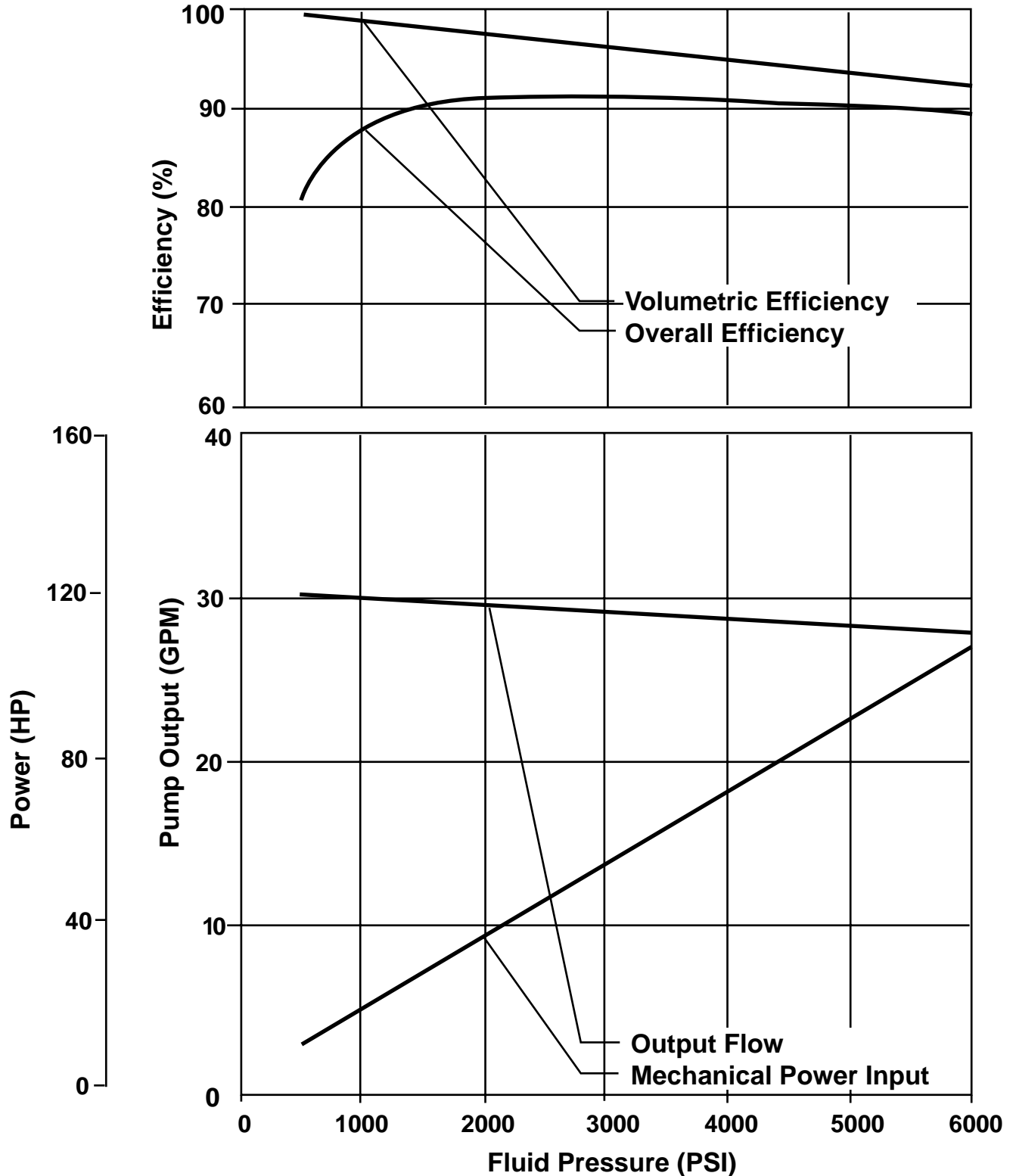

These curves DO NOT reflect charge pump losses

Pump Performance 18 Degrees Swash Angle Model 4621 1800 RPM

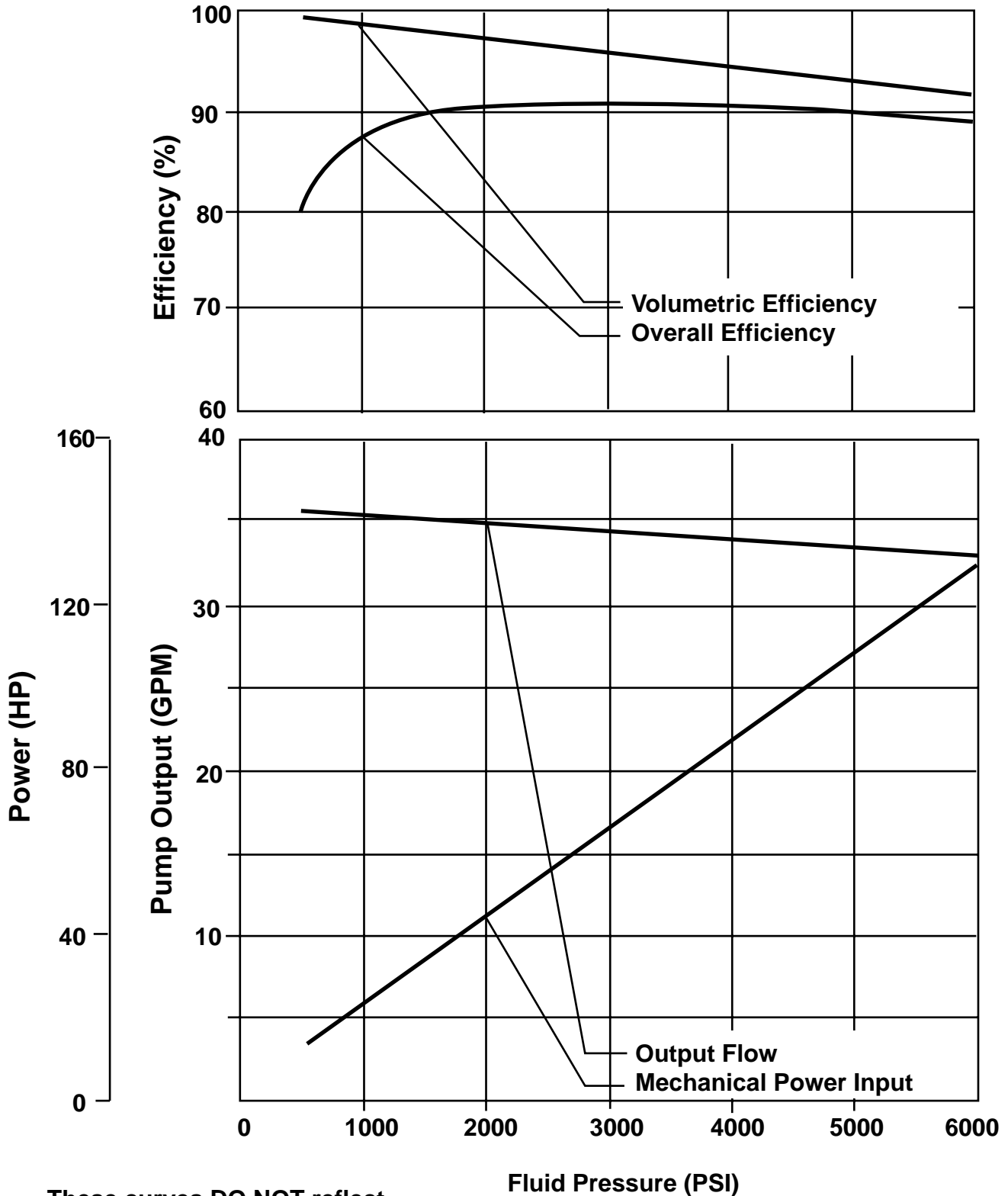

These curves DO NOT reflect charge pump losses

Pump Performance 18 degrees Swash Angle Model 5421 1800 RPM

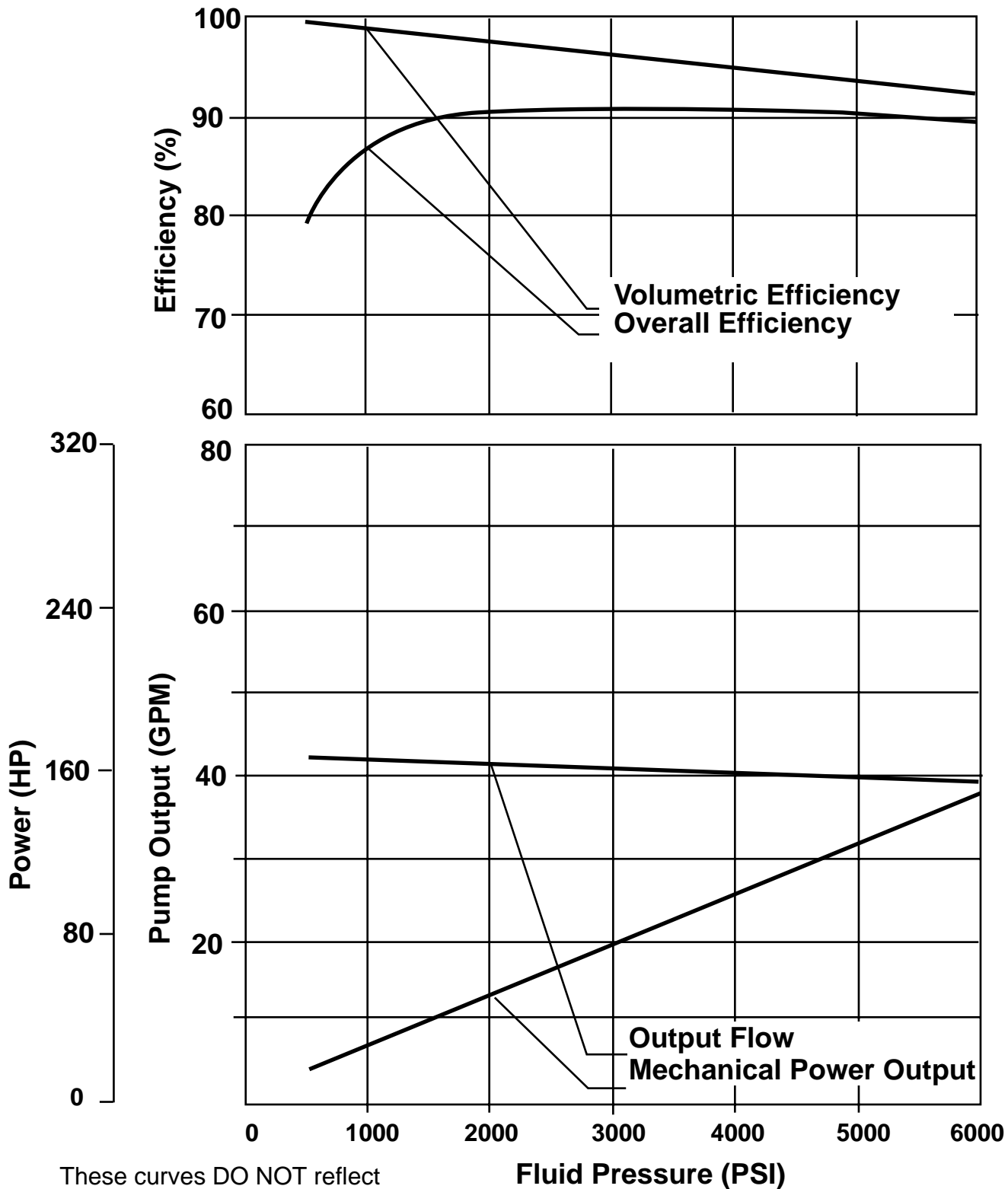

These curves DO NOT reflect
charge pump losses

Pump Performance 18 Degree Swash Angle Model 6421 1800 RPM

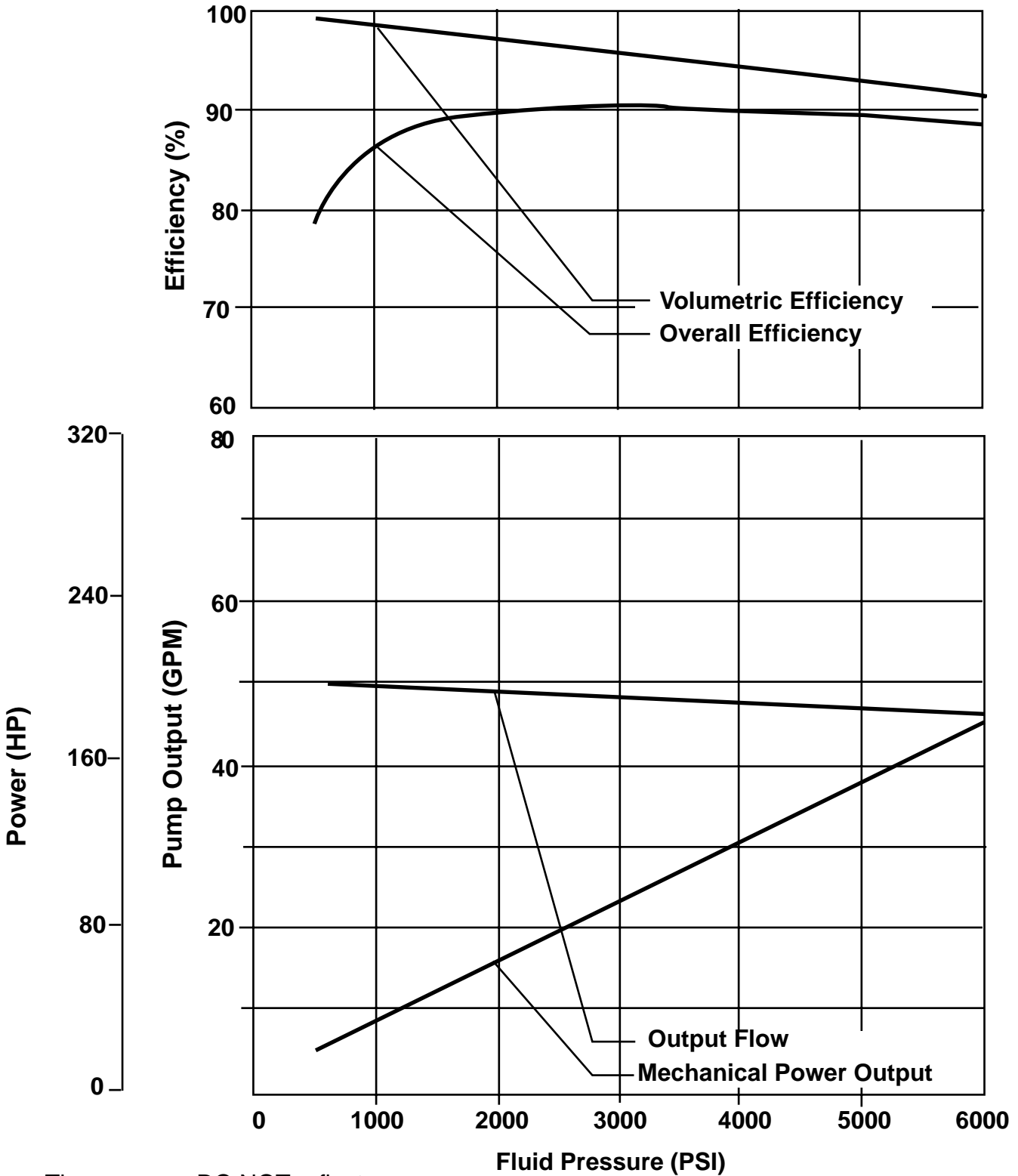

These curves DO NOT reflect charge pump losses

Pump Performance 18 Degrees Swash Angle Model 7620 1800 RPM

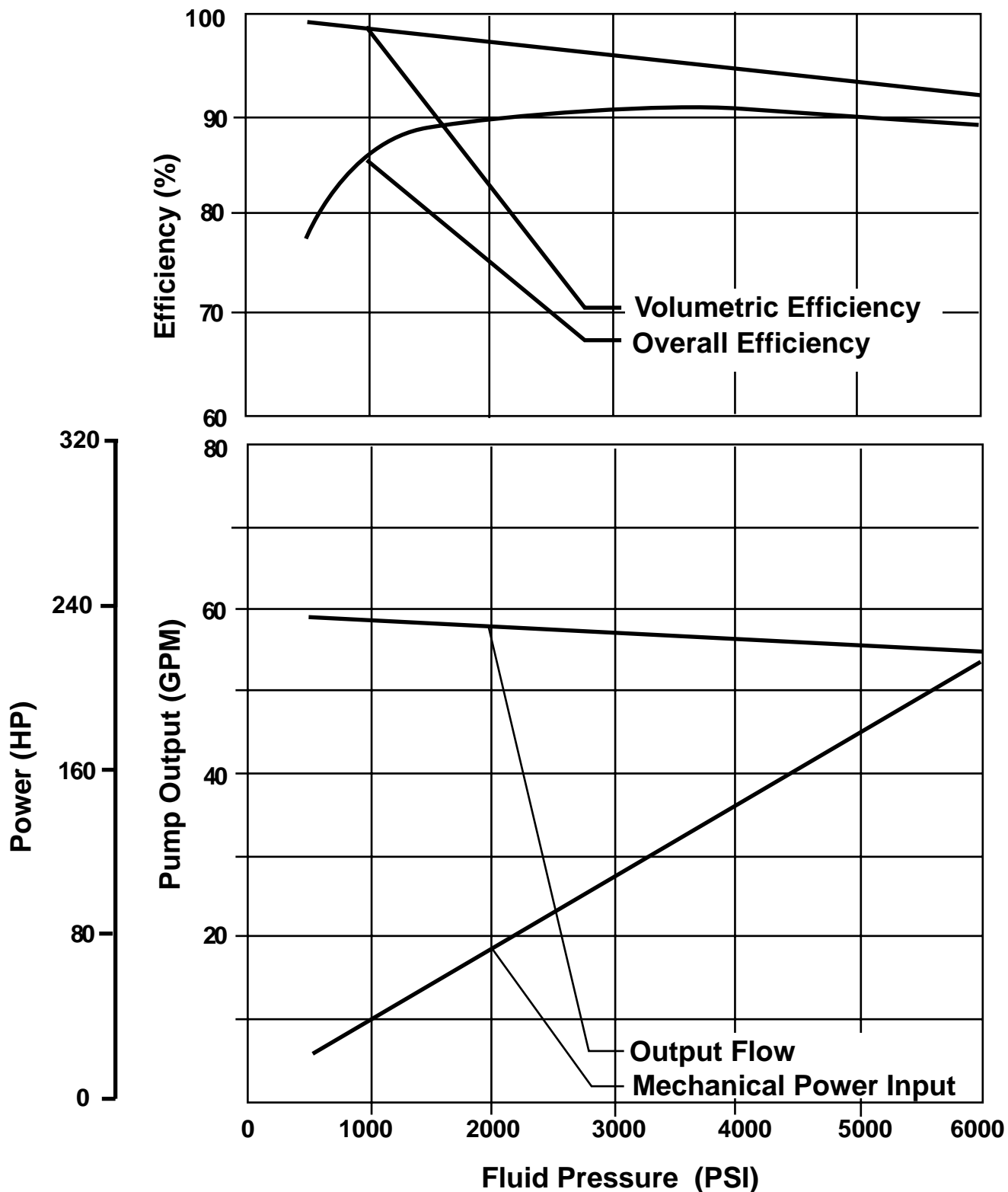

These curves DO NOT reflect charge pump losses

Motor Performance 15.5 Degrees Swash Angle Model 3331/3341

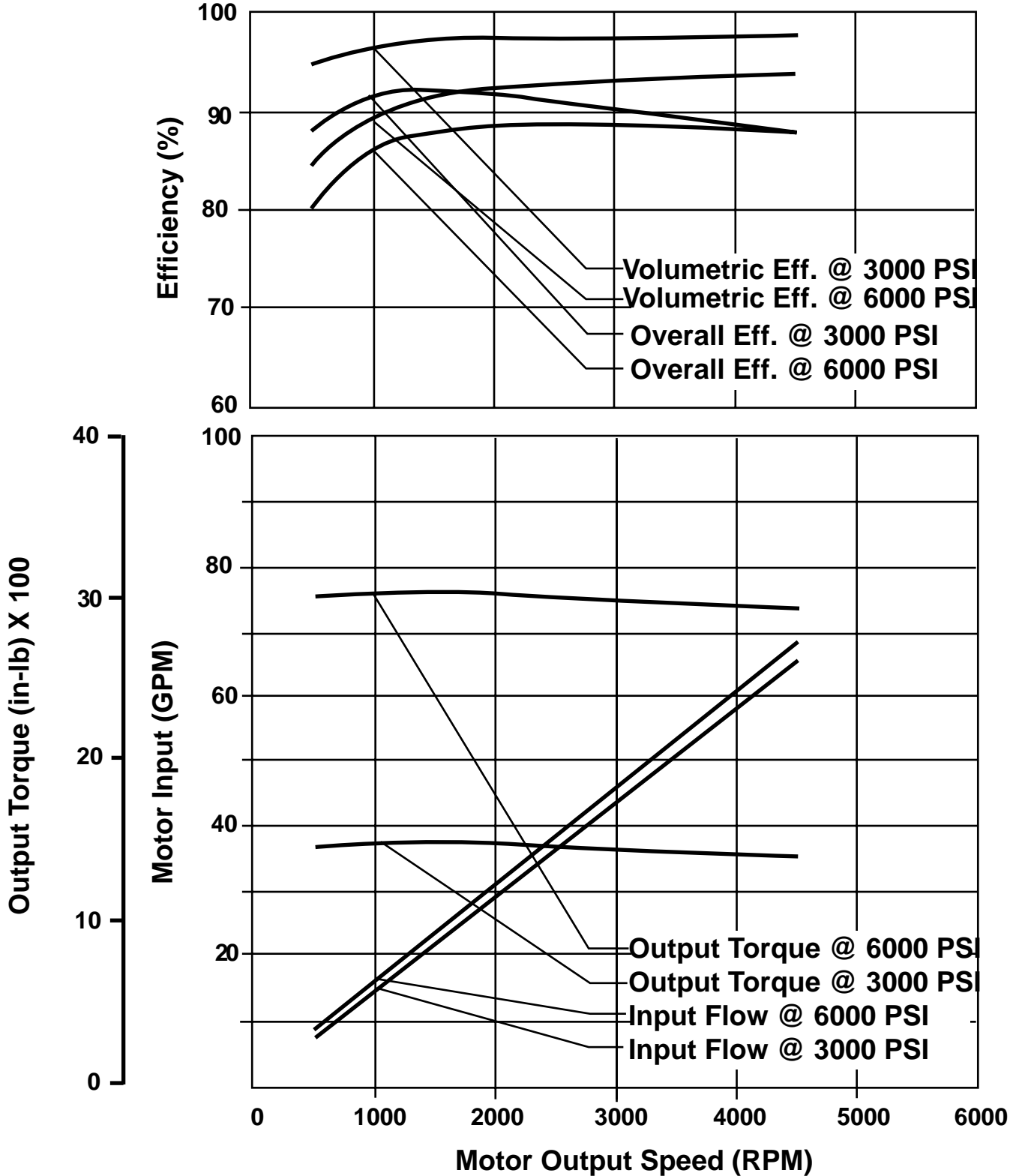

Motor Performance 10 Degrees Swash Angle Model 3341

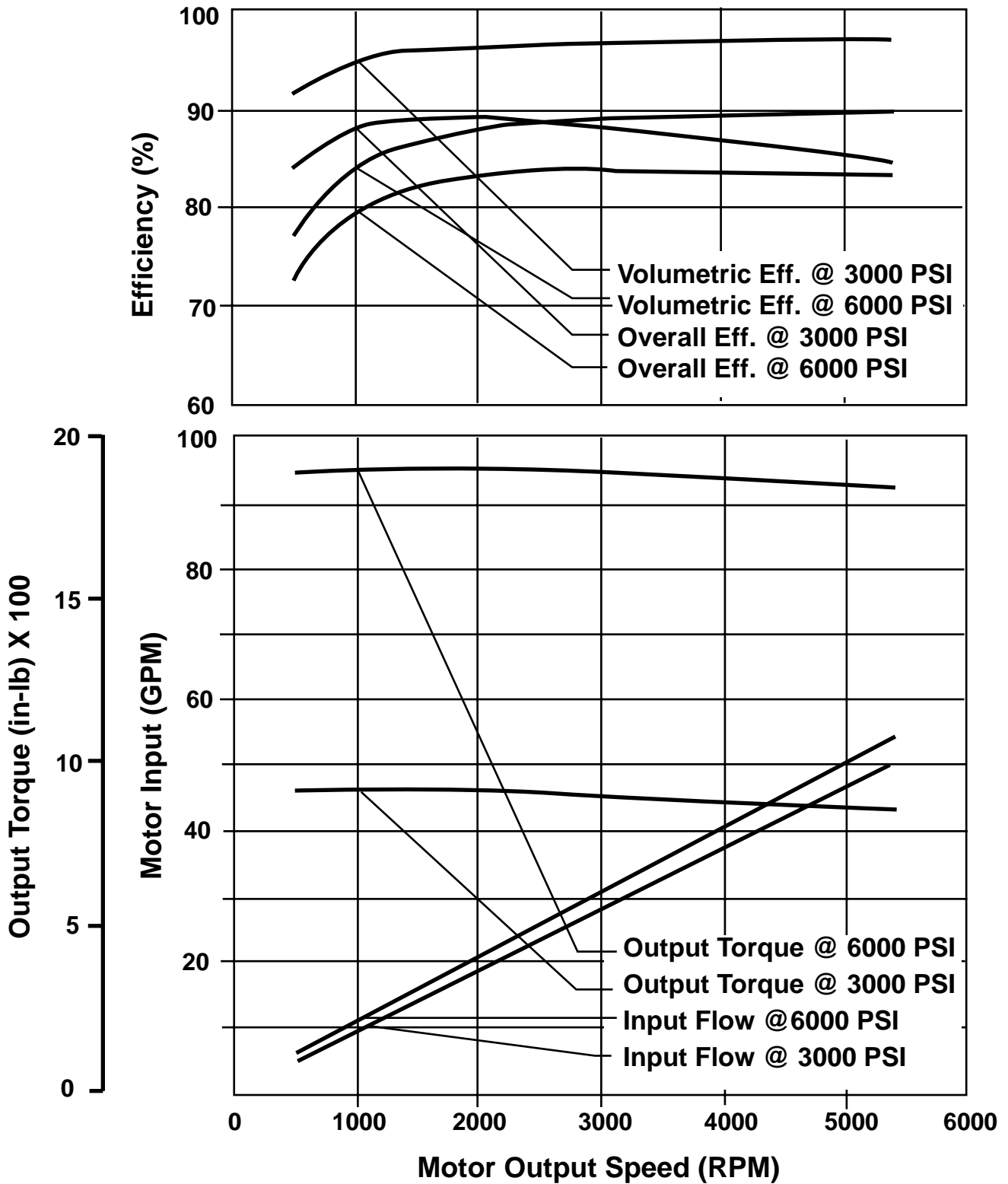

Motor Performance 18 Degrees Swash Angle Model 3931/3941

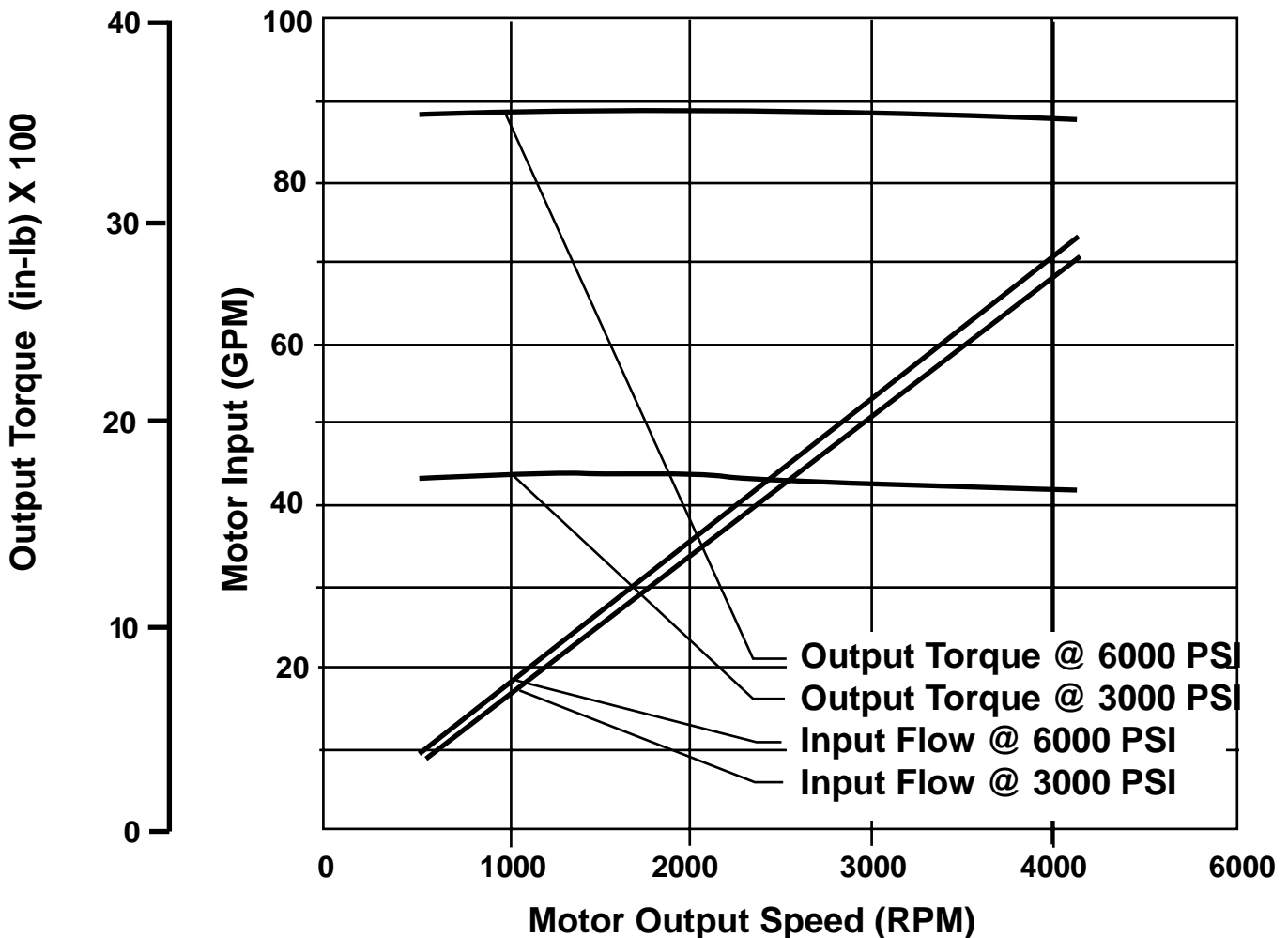
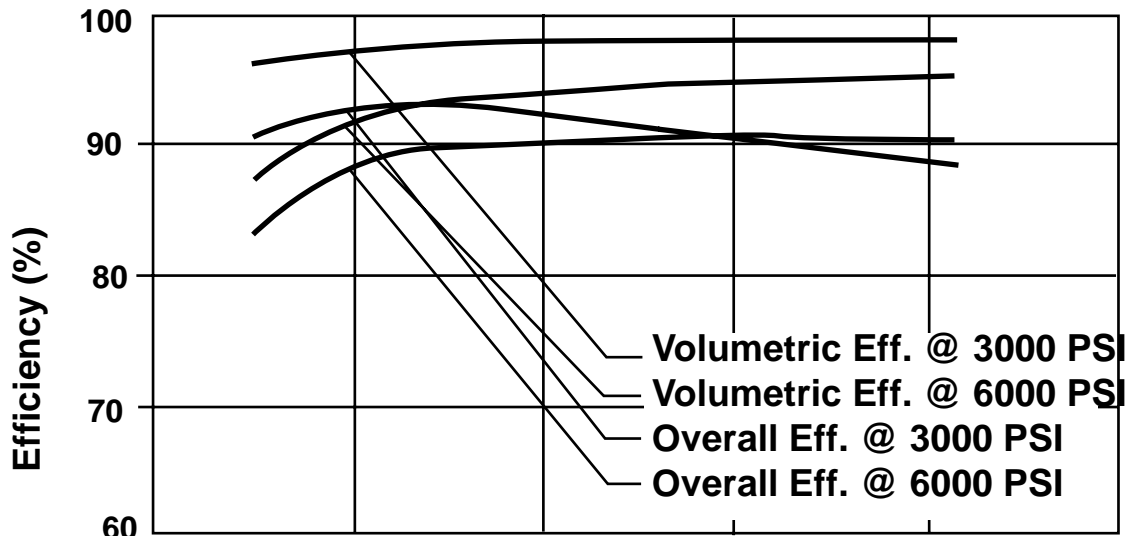

Motor Performance 10 Degrees Swash Angle Model 3941

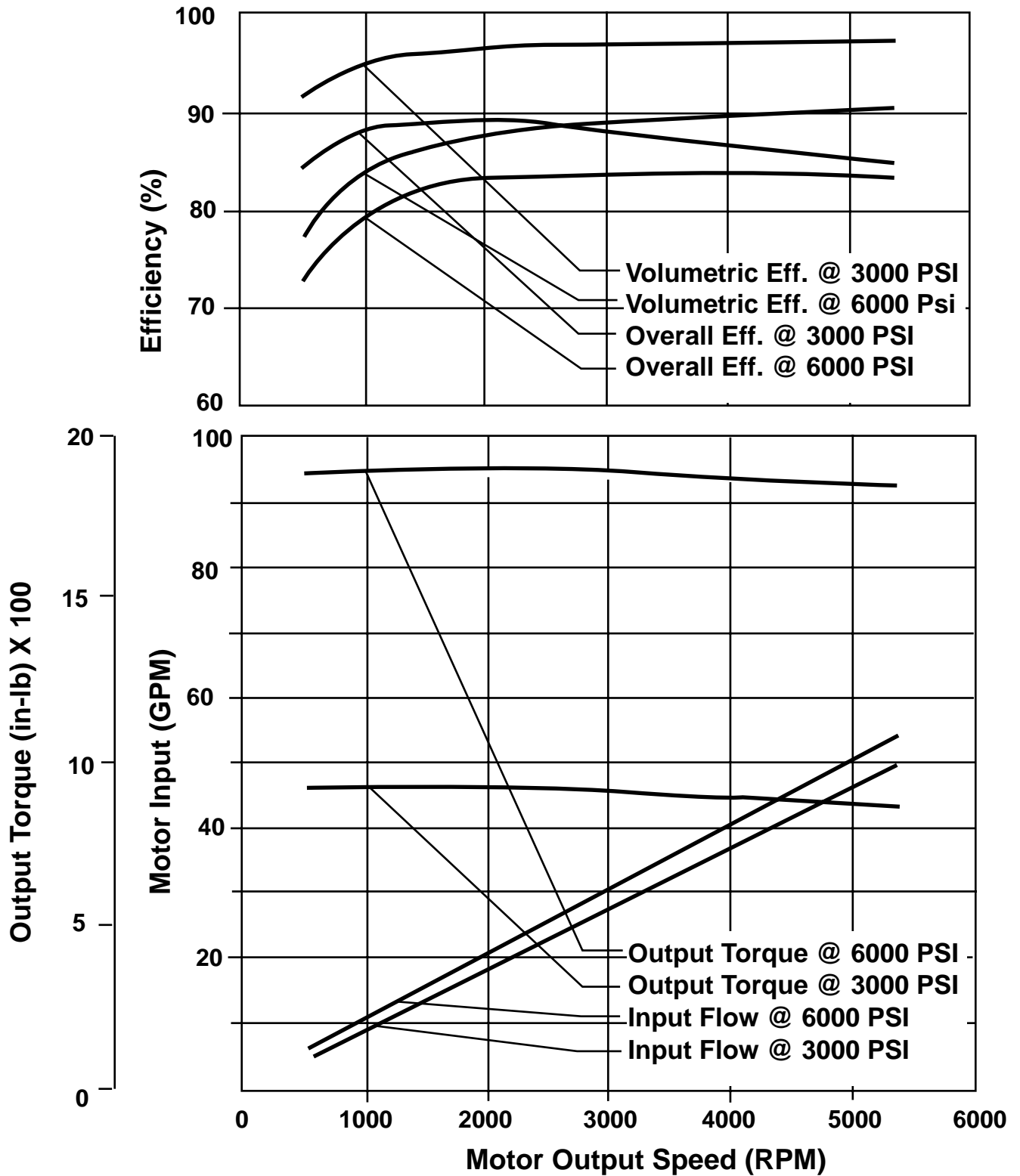

Motor Performance 18 Degrees Swash Angle Model 4631/4641

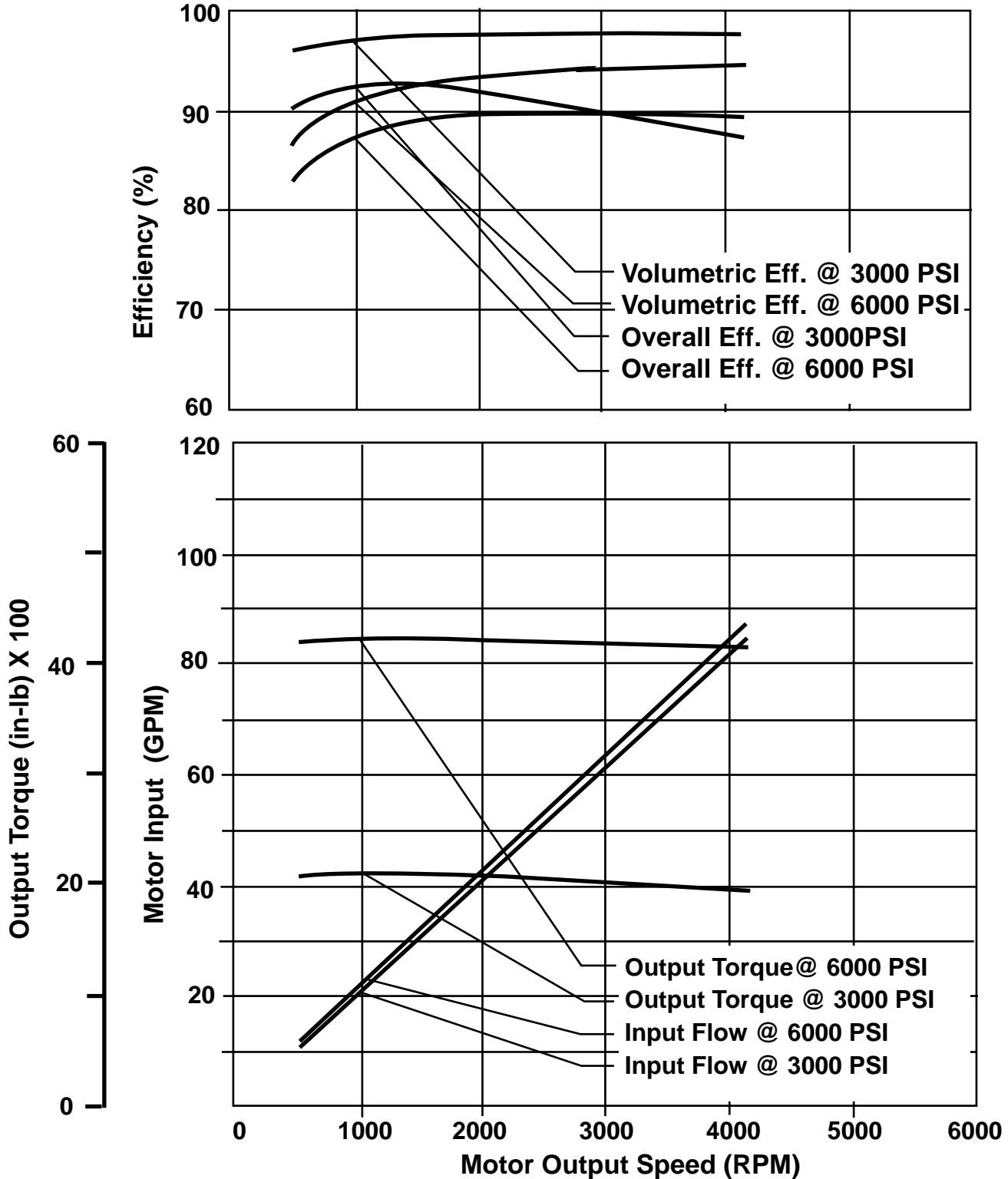

Motor Performance 10 Degrees Swash Angle Model 4641

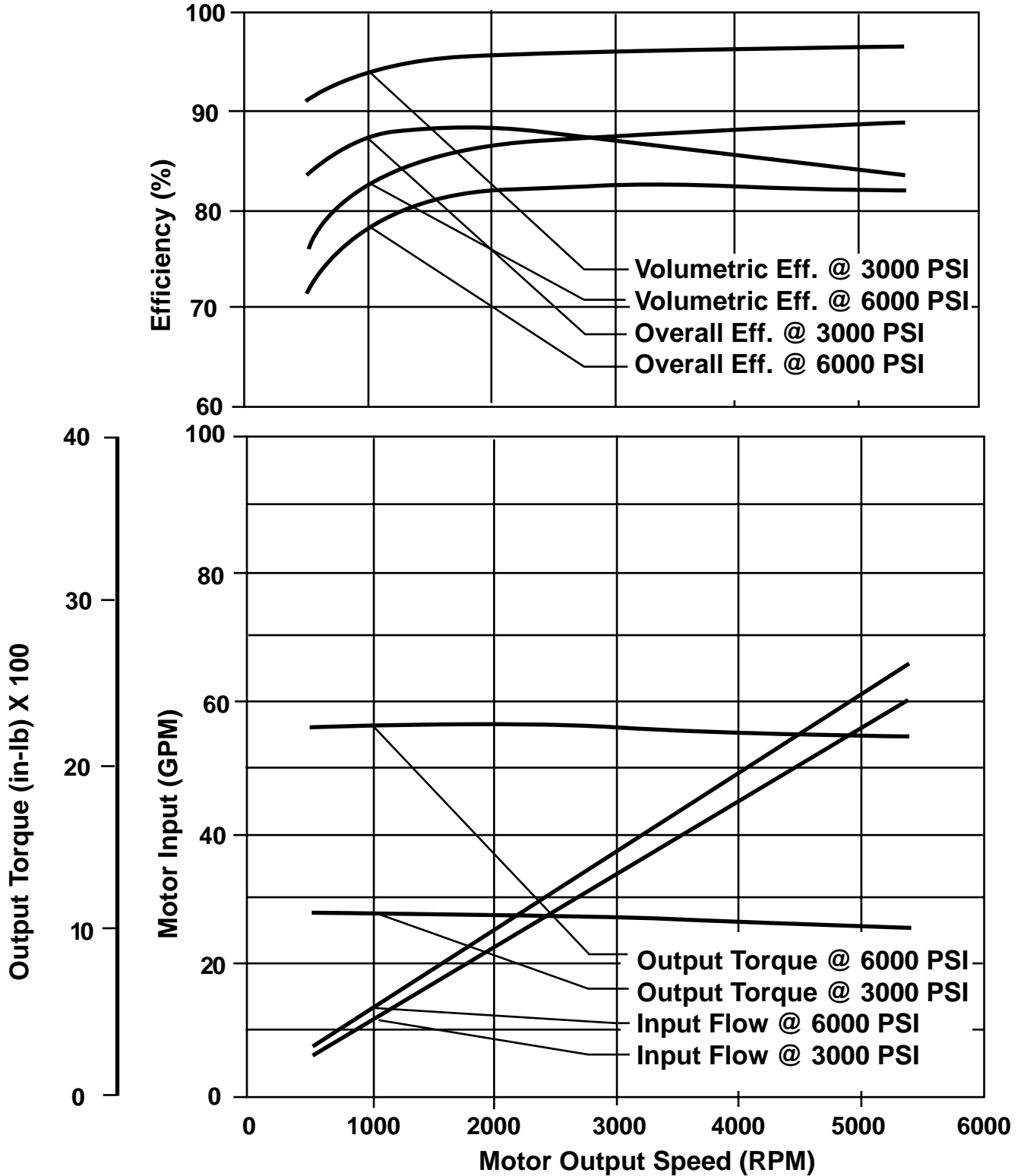

Motor Performance 18 Degrees Swash Angle Model 5431/5441

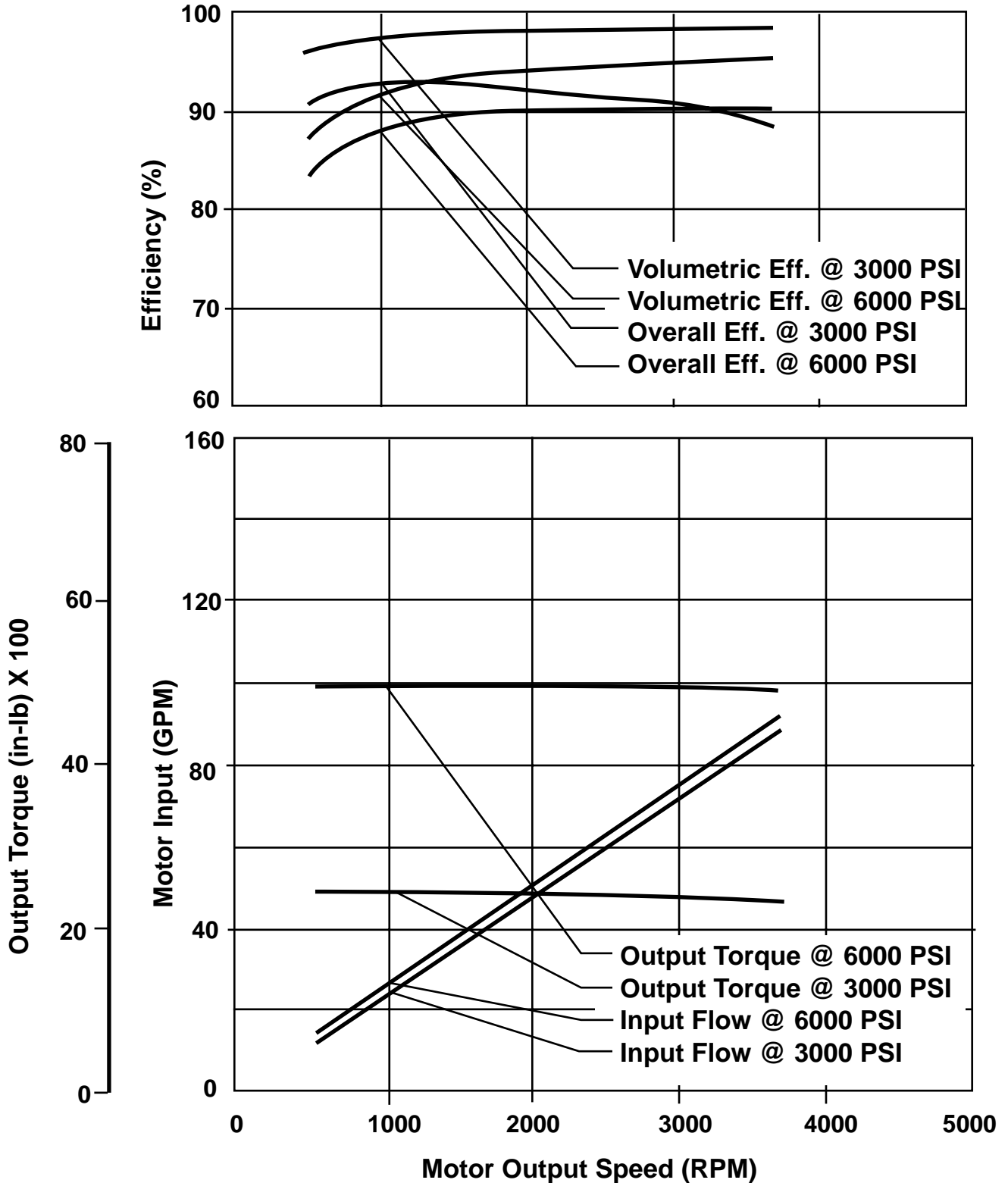

Motor Performance 10 Degrees Swash Angle Model 5441

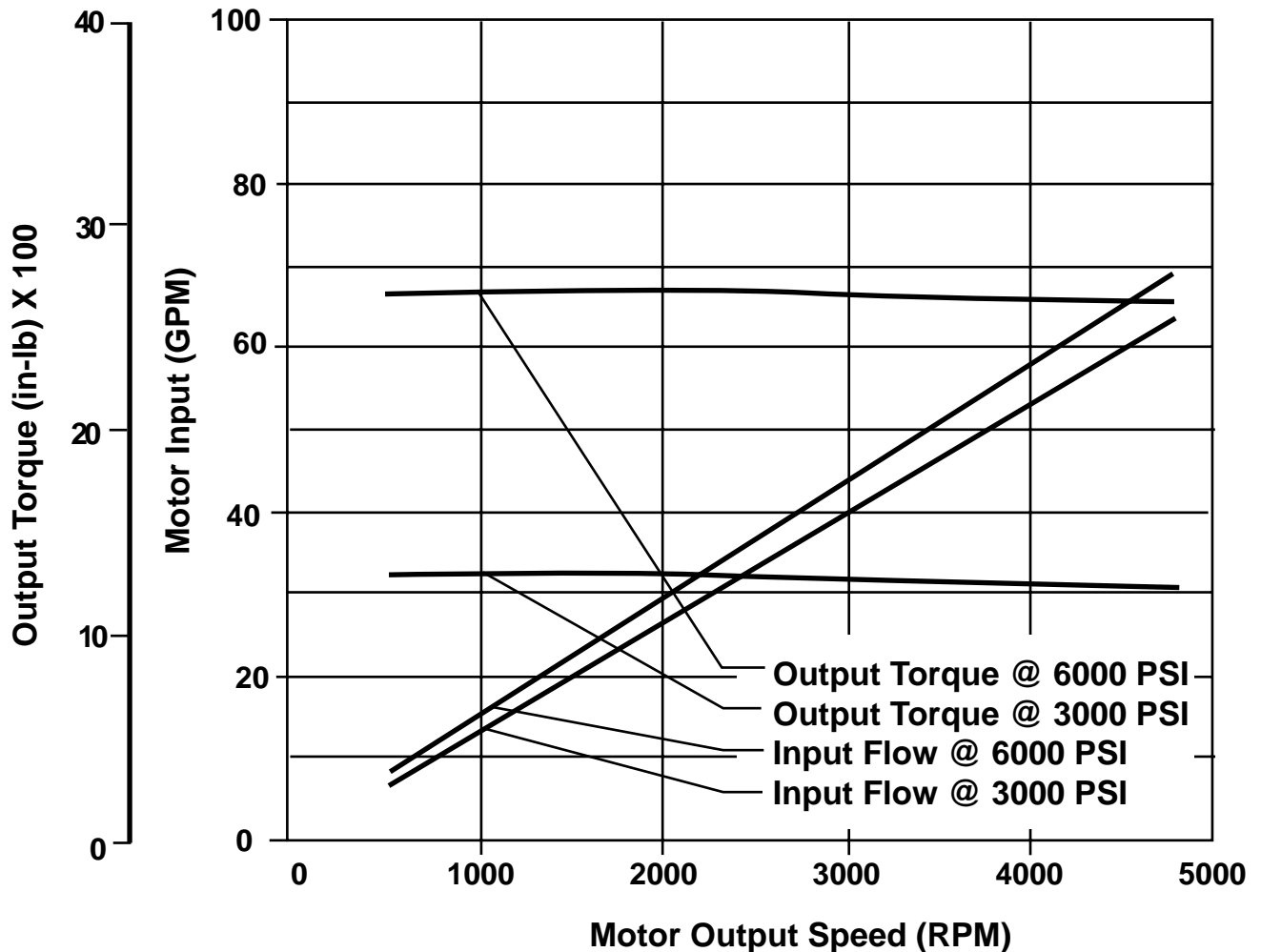
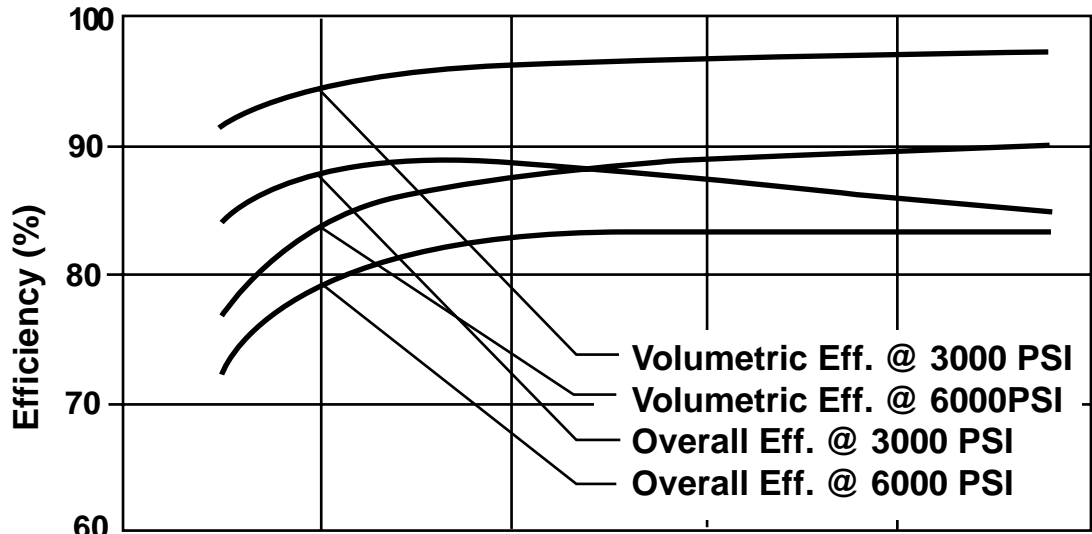

Motor Performance 18 Degrees Swash Angle Model 6431/6441

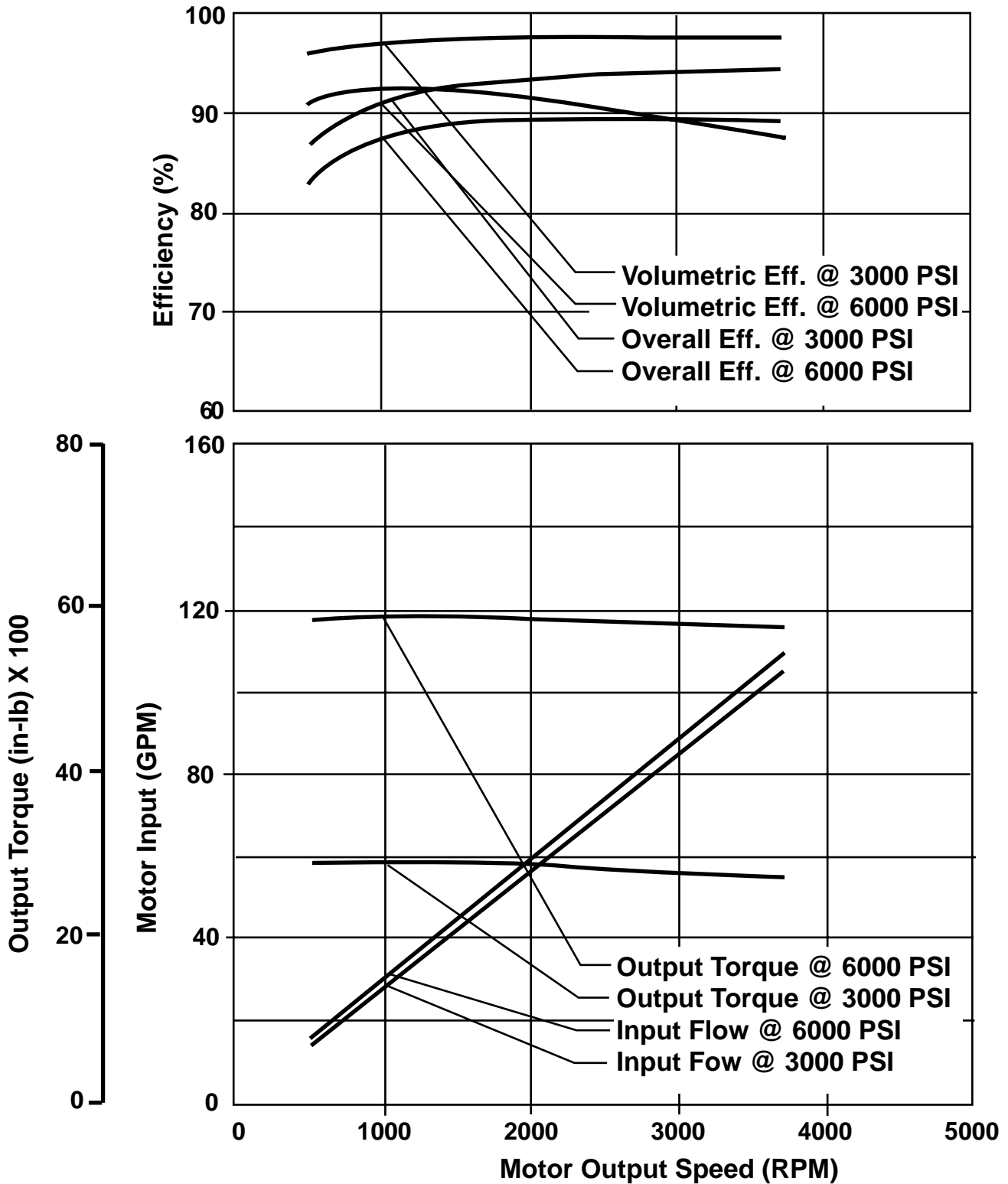

Motor Performance 10 Degrees Swash Angle Model 6441

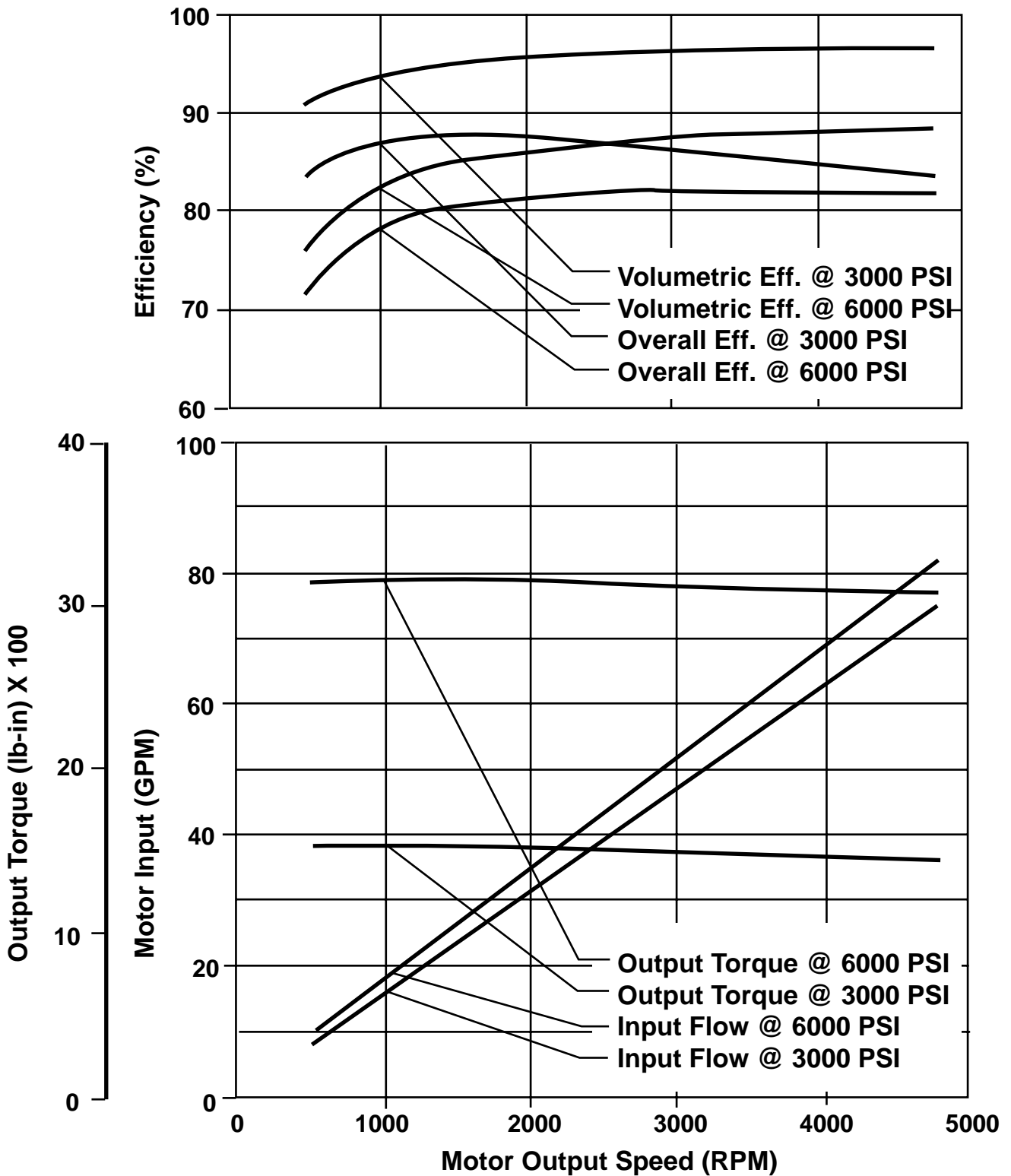

Motor Performance 18 Degrees Swash Angle Model 7630/7640

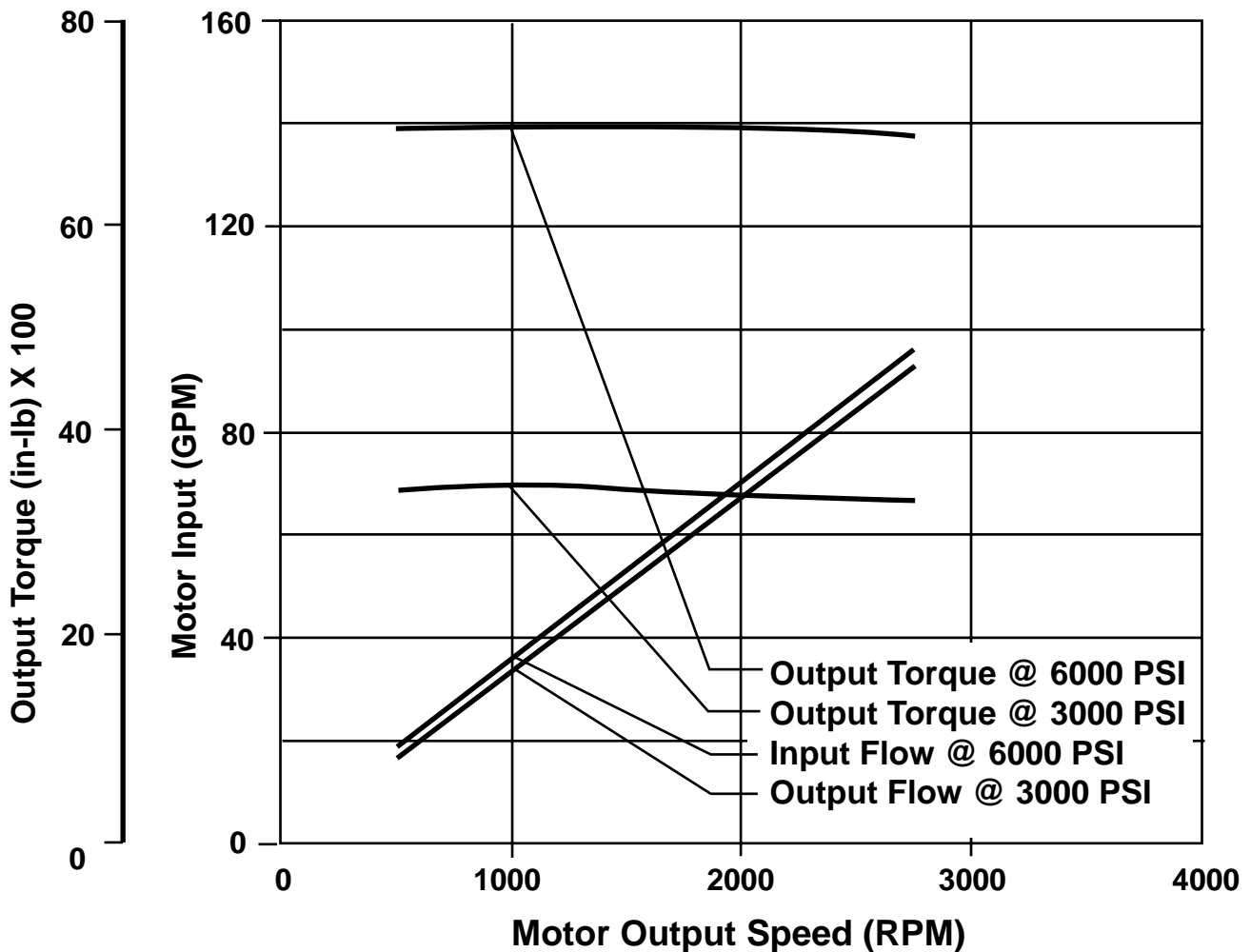
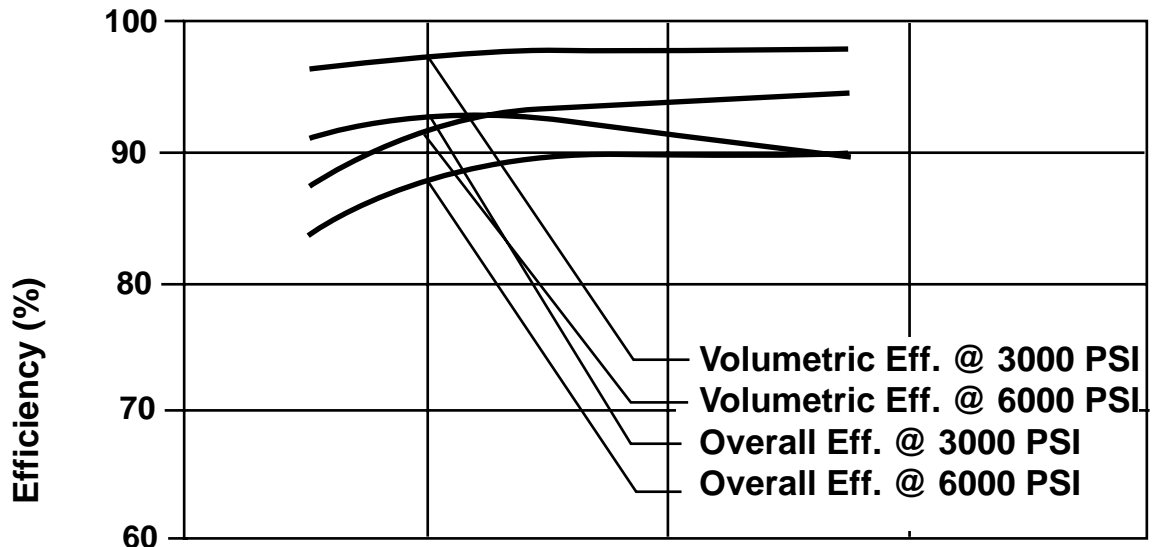

Motor Performance 10 Degrees Swash Angle Model 7640

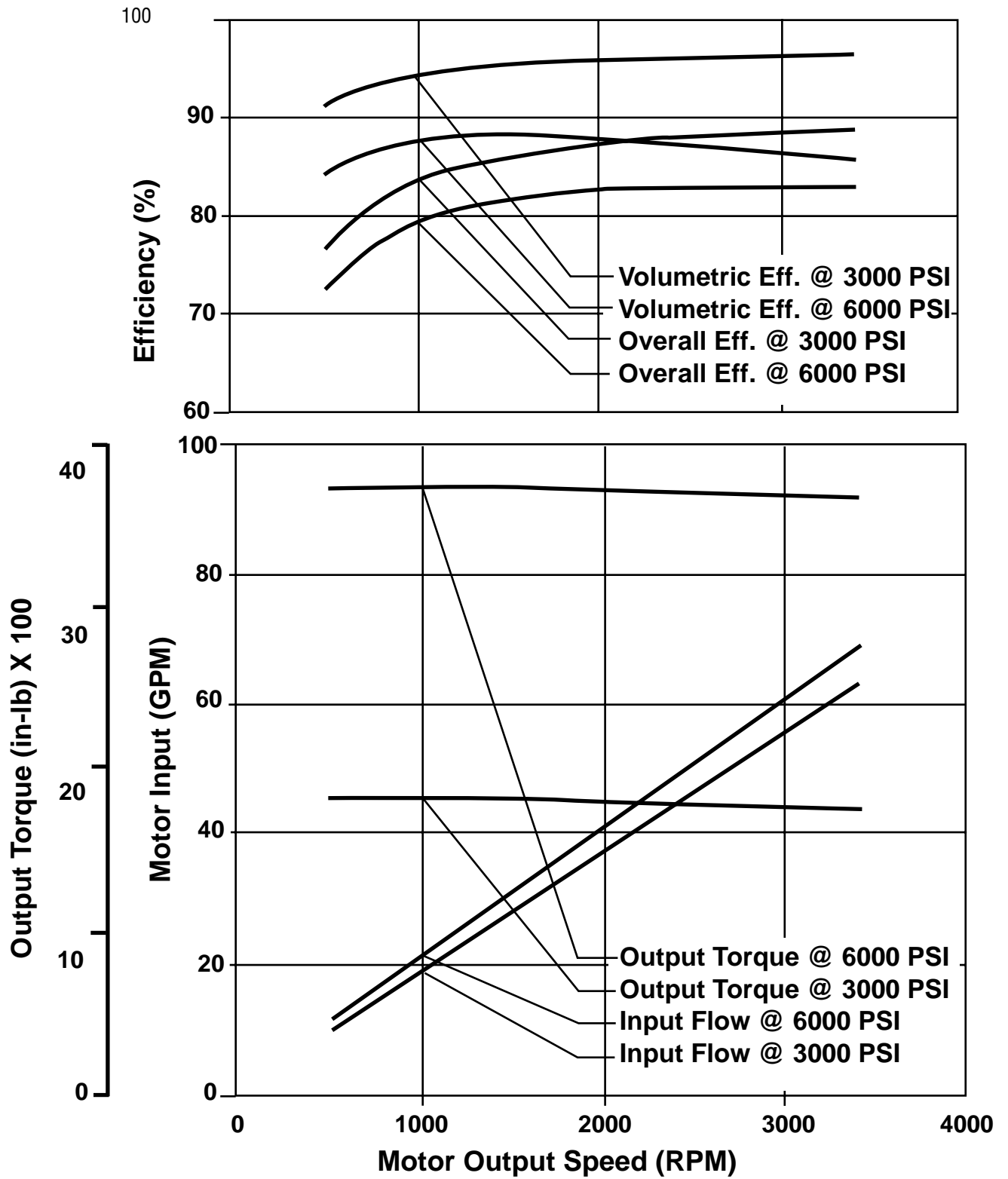

Application Examples

XYZ Crane Co. Calculations

Power Range Calculations

$$\begin{aligned}
 P.R.m &= \frac{(Ts)(Ns)}{(63025)(Er)} &&= \frac{(2471.67)(3.316)}{(2200)(.92)(.97)} \\
 &= \frac{(95,000)(4.5)}{(5252)(.92)} &&= 4.000 \text{ in}^3/\text{rev.} \\
 &= 88.5 \text{ hp} &&\text{Therefore use a 39 PV.}
 \end{aligned}$$

Motor Selection

$$P.R. em \geq P.R.$$

P.R. em as applied must be adjusted due to the maximum relief valve pressure limit of 4500 PSI.

Therefore:

$$\begin{aligned}
 P.R.em \text{ (as applied)} &\geq (P.R.m)(6000/Dp) \\
 &\geq \frac{(88.5)(6000)}{(4500)} \\
 &\geq 118 \text{ hp}
 \end{aligned}$$

Therefore, try a Model 33 fixed displacement motor.

Final Drive Ratio Selection

$$T_m = \frac{T_s}{(FDR)(Er)}$$

$$T_m = \frac{(P) (T \text{ from Table 5 @ 6000psi})}{6000}$$

$$= \frac{(4500) (3008)}{6000}$$

$$= 2256 \text{ lb-in}$$

$$FDR = \frac{T_s}{(T_m)(Er)}$$

$$= 549.26:1$$

Pump Selection

$$\begin{aligned}
 N_m &= (FDR)(Ns) \\
 &= (549.26) (4.5) \\
 &= 2471.67 \text{ RPM}
 \end{aligned}$$

$$D_p = \frac{(N_m)(D_m)}{(N_p)(E_{vp})(E_{vm})}$$

Overspeed Calculations

$$N_{m \text{ max}} = \frac{(D_p)(N_e)(E_{os})(IDR)}{(D_m)(E_{vp})(E_{vm})}$$

$$\text{Assume } N_{e \text{ max}} = 2640 \text{ RPM}$$

$$E_{os} = \frac{N_{e \text{ max}}}{N_e}$$

$$N_{m \text{ max}} = \frac{(3.885) (2200) (1.2)(1)}{(3.316) (.96) (.97)}$$

$$= 3322 \text{ RPM O.K.}$$

$$N_{p \text{ max}} = N_{e \text{ max}}$$

$$= 2640 \text{ RPM O.K.}$$

Horsepower Limiting Pressure

$$T_p = \frac{(P_i)(63025)(E_{ir})}{(N_e)(IDR)}$$

$$= \frac{(100)(63025)(1)}{(2200)(1)}$$

$$= 2865 \text{ lb-in}$$

$$p = \frac{(T_p)(2\pi)(E_{tp})}{D_p}$$

$$= \frac{(2865)(2\pi)(.95)}{(3.885)}$$

$$= 4402 \text{ PSI}$$

This pressure is too high. The limit is 3500 PSI when the pump is at maximum displacement.

Therefore, use a 46 PV and recalculate Nm max for overspeed.

Overspeed Calculations

$$Nm \text{ max} = \frac{(Dp)(Ne)(Eos)(IDR)}{(Dm)(Evp)(Evm)}$$

$$Nm \text{ max} = \frac{(4.594)(2200)(1.2)(1)}{(3.316)(.96)(.97)}$$

Nm max = 3928 rpm This is OK.

Check Speed Swing Function

$$Ns = \frac{Nm}{FDR}$$

$$Nm = \frac{(Np)(Dp)(Evp)(Epm)}{DM}$$

$$= \frac{(2200)(4.594)(.96)(.97)}{3.316}$$

= 2838 RPM

$$Ns = \frac{2838}{549.26} = 5.17 \text{ rpm}$$

This is OK.

Horsepower Limiting Pressure

$$Tp = 2492 \text{ lb-in}$$

$$p = \frac{(Tp)(2\pi)(Etp)}{Dp}$$

$$= \frac{(2865)(2\pi)(.95)}{4.594}$$

$$= 3723 \text{ PSI}$$

O.K. It is over 3500 PSI, but the duty cycle is light.

Therefore, a 46 PV - 33 MF is recommended with a final drive ratio of 549.26 to 1.



Application Data Sheet

Light / Medium / Heavy Duty Hydrostatic Transmission
Eaton Corporation Hydraulics Division 15151 Highway 5 Eden Prairie MN 55344

Date: 21/8/89
Application No. 100 A
MPS/EP No. _____

Company Name XYZ Crane Co. Completed By Roger Benkovic

Address _____

City _____ Phone No. _____

State _____ Zip _____ Contact _____

MOBILE APPLICATION

Vehicle Description Mobile Crane

Vehicle Weight: Net _____ Gross _____ Max. Weight on Drive Wheels _____

Vehicle Ground Speed: Working Range _____ MPH

Road Range _____ MPH

Max. Desired Gradeability _____%; Max. Desired Drawbar or Tractive Effort _____

Coefficient of Traction (adhesion) _____

Coefficient of Rolling Resistance _____

Rolling Radius (include optional tires) _____

Vehicle Accessories: Trailers Wheel Weights Other (describe) _____
To Complete See Reverse Side

NON MOBILE APPLICATION

Description of Application Swing (Slewing)

Output Torque Required from Transmission: Continuous _____ Maximum 95,000 lb. ft.

Output Speed Required from Transmission: Minimum _____ Maximum 4.5 rpm

To Complete See Reverse Side—

WINCH APPLICATION

Drum Diameter _____ Drum RPM Maximum _____

Line Pull Required _____ lbs

Line Speed: Feet per Minute Maximum _____

Cable Diameter Inches _____ Nestled Cable Diameter _____

Cable Wraps _____

POWER SOURCE

Gas Diesel Electric Make and Model No. _____
Horsepower Rating (@ Full Loaded Governed Speed) 100 HP @ 2200 RPM

PUMP INPUT

Input Rotation (Facing Input Drive Shaft): CW CCW

Input Drive: Belt Chain Direct/Coupling

Input Drive Ratio 1 : 1

Normal Input Horsepower 87 Input RPM at 2200 rpm

Maximum Input Horsepower _____ Input RPM _____

MOTOR OUTPUT

Output Drive: Belt Chain Direct/Coupling Axle

Multispeed Gear Box Ratios 1st _____ 2nd _____ 3rd _____ 4th _____

Axle or Final Drive Ratio _____ Drive Ratio Efficiency _____

Eaton to select final drive ratio

CONTROL INPUT

Hand Lever Foot Pedal Other (describe) Torque Sensing

DUTY CYCLE:

Describe Operating Conditions (% time) 4500 psi max. pressure due to plumbing
considerations

EATON CORP.
 HYDRAULICS DIVISION
 15151 HIGHWAY 5
 EDEN PRAIRIE, MN 55344, USA

THIS DATA IS A PERFORMANCE PREDICTION BASED ON GENERAL EMPIRICAL FORMULAS FOR THE GIVEN APPLICATION INFORMATION. IT DOES NOT CONSTITUTE APPLICATION APPROVAL OR ASSURANCE OF SIMILAR RESULTS FOR ANY PARTICULAR EQUIPMENT.

DATE: 12/19/1997

TITLE: XYZ CRANE CO. - SWING DRIVE

PUMP MODEL	MOTOR MODEL	NO. OF MOTORS	RELIEF PRESS(PSI)	CHARGE PRESS(PSI)	CHARGE PUMP LOSS(HP)
4621	3331	1	4500.0	160.0	1.50

AVAILABLE TRANSMISSION INPUT POWER 100.00 HP

PUMP PERFORMANCE FOR MODEL 4621

	14.81	3.00	6.00	9.00	12.00	15.00	18.00
SWASH ANGLE (DEG.)	14.81	3.00	6.00	9.00	12.00	15.00	18.00
DISPLACEMENT (CU.IN.)	3.7382	.7410	1.4861	2.2408	3.0053	3.7885	4.5970
INPUT SPEED (RPM)	2200.	2200.	2200.	2200.	2200.	2200.	2200.
INPUT TORQUE (LBF.IN.)	2821.80	630.82	1171.15	1721.16	2280.94	2821.80	2821.80
OUTPUT FLOW (GPM)	32.68	4.23	11.33	18.37	25.91	33.17	41.71
INPUT POWER (HP)	98.50	22.02	40.88	60.08	79.62	98.50	98.50
SYS. PRESSURE (PSI)	4500.00	4500.00	4500.00	4500.00	4500.00	4440.60	3652.18
VOLUMETRIC EFFICIENCY	91.79	59.88	80.04	86.07	90.53	91.94	95.26
TORSIONAL EFFICIENCY	94.88	84.13	90.88	93.24	94.36	94.89	94.69
OVERALL EFFICIENCY	87.09	50.38	72.73	80.26	85.43	87.24	90.21

MOTOR PERFORMANCE FOR MODEL 3331

	15.50	15.50	15.50	15.50	15.50	15.50	15.50
SWASH ANGLE (DEG.)	15.50	15.50	15.50	15.50	15.50	15.50	15.50
DISPLACEMENT (CU.IN.)	3.3159	3.3159	3.3159	3.3159	3.3159	3.3159	3.3159
OUTPUT SPEED (RPM)	2167.06	242.85	723.11	1199.29	1709.42	2202.86	2815.54
OUTPUT TORQUE(LBF.IN.)	2259.57	2187.59	2257.75	2272.19	2268.56	2227.44	1802.66
OUTPUT FLOW (GPM)	31.11	3.49	10.38	17.22	24.54	31.62	40.42
OUTPUT POWER (HP)	77.69	8.43	25.90	43.24	61.53	77.85	80.53
VOLUMETRIC EFFICIENCY	95.19	82.50	91.64	93.72	94.70	95.32	96.90
TORSIONAL EFFICIENCY	95.15	92.12	95.07	95.68	95.52	95.05	93.53
OVERALL EFFICIENCY	90.57	75.99	87.12	89.67	90.46	90.60	90.63
PUMP&MTR. EFFICIENCY	78.88	38.28	63.36	71.97	77.28	79.04	81.76
HYD. TRAN. EFFICIENCY	77.69	35.84	61.12	70.21	75.85	77.85	80.53

SWING PERFORMANCE

	95151.	92151.	95074.	95682.	95529.	93797.	75965.
OUTPUT TORQUE(LBF.FT.)	95151.	92151.	95074.	95682.	95529.	93797.	75965.
OUTPUT SPEED (RPM)	3.9	.4	1.3	2.2	3.1	4.0	5.1

GEAR RATIO = 549.26

GEAR EFFICIENCY = 92.00

ABC Winch G.m.b.H. Calculations

The final drive is specified; therefore, calculation of a P.R.w. is not necessary.

Motor Selection

$$T_m = \frac{T_d}{(FDR)(Er)}$$

$$T_d = (L.P.) (D.R. \text{ eff})$$

D.R. eff = Effective Drum Radius

$$D.R. \text{ eff} = D.R. + (.5) (d.c.) + (N-1) (d.c.)$$

D.R. = Drum Radius

d.c. = Cable Dia.

N = Number of Wraps

$$\begin{aligned} D.R. \text{ eff} &= D.R. + (.5) (25) + (5-1) (25) \\ &= 280 + 12,5 + 100 \\ &= 392,5 \text{ mm (Note: } 392,5 \text{ mm} = 0,3925 \text{ m)} \end{aligned}$$

$$\begin{aligned} T_d &= (90000) (,3925) \\ &= 35,325 \text{ Nm} \end{aligned}$$

$$\begin{aligned} T_m &= \frac{35,325}{(54,3)(,95)} \\ &= 684,8 \text{ N-m} \end{aligned}$$

T_m for a 64 MF = 659 N-m at 414 bar

Therefore, use a 64 MF with 414 bar relief valves

Pump Selection

$$N_m = \frac{(L.S.)(FDR)(9549,3)}{D.R. \text{ eff}}$$

$$\begin{aligned} D.R. \text{ eff} &= 280 + (.5) (25) + (1 - 1) (25) (.86603) \\ &= 292,5 \text{ mm (first layer)} \end{aligned}$$

$$N_m = \frac{(1,5)(54,3)(9549,3)}{292,5}$$

$$= 2659 \text{ rpm}$$

$$N_m = \frac{(Nm)(Dm)}{(Np)(Evp)(Evm)}$$

$$= \frac{(2569) (105,4)}{(2300) (.96) (.97)}$$

$$= 130.86 \text{ cc}$$

Therefore, use a 76 PV.

$$\begin{aligned} N_m &= \frac{(Dp)(Np)(Evp)(Evm)}{Dm} \\ &= \frac{(124,8) (2300) (.96) (.97)}{105,4} \\ &= 2536 \text{ rpm} \end{aligned}$$

$$\begin{aligned} L.S. &= \frac{(Nm_n) (D.R. \text{ eff})}{(FDR) (9549,3)} \\ &= \frac{(2536) (292,5)}{(54,3) (9549,3)} \\ &= 1,43 \text{ m/sec.} \end{aligned}$$

Overspeed Calculations

$$N_m \text{ max} = \frac{(Dp)(Ne)(Eos)(IDR)}{(Dm)(Evp)(Evm)}$$

Assume Eos = 1.2

$$\begin{aligned} N_m \text{ max} &= \frac{(124,8) (2300) (1,2)(1)}{(105,4) (.96) (.96) (.97)} \\ &= 3509 \text{ RPM} \end{aligned}$$

O.K. 64 MF is capable of 3720 RPM

$$\begin{aligned} N_p \text{ max} &= (Ne) (Eos) (IDR) \\ &= (2300) (1,2) (1) \\ &= 2760 \text{ RPM} \end{aligned}$$

O.K. for a 76 PV

Power Limiting Pressure

$$T_p = \frac{(Pi)(9549,3)(Eir)}{(Ne)(IDR)}$$

$$\begin{aligned} &= \frac{(60) (9549,3) (1)}{(2300) (1)} \\ &= 249,1 \text{ N-m} \end{aligned}$$

$$P = \frac{(T_p)(2\pi)(Etp)}{(Dp)}$$

$$\begin{aligned} &= \frac{(249,1) (20\pi) (.95)}{124,8} \\ &= 119 \text{ Bar} \end{aligned}$$



Application Data Sheet

Light / Medium / Heavy Duty Hydrostatic Transmission

Eaton Corporation Hydraulics Division 15151 Highway 5 Eden Prairie MN 55344

Date: 21/8/89

Application No. 101 A

MPS/EP No. _____

Company Name ABC Winch GMBH

Completed By Roger Benkovic

Address _____

City _____ Phone No. _____

State _____ Zip _____ Contact _____

MOBILE APPLICATION

Vehicle Description _____

Vehicle Weight: Net _____ Gross _____ Max. Weight on Drive Wheels _____

Vehicle Ground Speed: Working Range _____ MPH

Road Range _____ MPH

Max. Desired Gradeability _____%; Max. Desired Drawbar or Tractive Effort _____

Coefficient of Traction (adhesion) _____

Coefficient of Rolling Resistance _____

Rolling Radius (include optional tires) _____

Vehicle Accessories: Trailers Wheel Weights Other (describe) _____

To Complete See Reverse Side

NON MOBILE APPLICATION

Description of Application Winch Drive

Output Torque Required from Transmission: Continuous _____ Maximum _____

Output Speed Required from Transmission: Minimum _____ Maximum _____

To Complete See Reverse Side—

WINCH APPLICATION

Drum Diameter 560 mm Drum RPM Maximum _____

Line Pull Required 90,000 Newtons

Line Speed: 1.5 m/sec minimum with empty drum

Cable Diameter Inches 25 mm Nestled Cable Diameter _____

Cable Wraps 5

POWER SOURCE

Gas Diesel Electric Make and Model No. _____
Power Rating (@ Full Loaded Governed Speed) 60 Kw @ 2300 RPM

PUMP INPUT

Input Rotation (Facing Input Drive Shaft): CW CCW

Input Drive: Belt Chain Direct/Coupling

Input Drive Ratio 1 : 1

Normal Input _____ Input RPM _____

Maximum Input Power 60 Kw Input RPM 2300

MOTOR OUTPUT

Output Drive: Belt Chain Direct/Coupling Axle

Multispeed Gear Box Ratios 1st _____ 2nd _____ 3rd _____ 4th _____

Final Drive Ratio 54.3:1 Drive Ratio Efficiency _____

CONTROL INPUT

Hand Lever Foot Pedal Other (describe) Mooring

DUTY CYCLE:

Describe Operating Conditions (% time) _____

EATON CORP.
 HYDRAULICS DIVISION
 15151 HIGHWAY 5
 EDEN PRAIRIE, MN 55344, USA

THIS DATA IS A PERFORMANCE PREDICTION BASED ON GENERAL EMPIRICAL FORMULAS FOR THE GIVEN APPLICATION INFORMATION. IT DOES NOT CONSTITUTE APPLICATION APPROVAL OR ASSURANCE OF SIMILAR RESULTS FOR ANY PARTICULAR EQUIPMENT.

DATE: 12/19/1997

TITLE: ABC WINCH G.m.b.H. Winch Drive

PUMP MODEL	MOTOR MODEL	NO. OF MOTORS	RELIEF PRESS(BAR)	CHARGE PUMP PRESS(BAR)	CHARGE PUMP LOSS(KW)
7620	6431	1	414.0	11.0	1.50

AVAILABLE TRANSMISSION INPUT POWER 60.00 KW

PUMP PERFORMANCE FOR MODEL 7620

	4.93	3.00	6.00	9.00	12.00	15.00	18.00
SWASH ANGLE (DEG.)	4.93	3.00	6.00	9.00	12.00	15.00	18.00
DISPLACEMENT (CU.CM.)	33.1325	20.1276	40.3661	60.8288	81.6339	102.9077	124.7875
INPUT SPEED (RPM)	2300.	2300.	2300.	2300.	2300.	2300.	2300.
INPUT TORQUE (N.M)	242.9	155.8	242.9	242.9	242.9	242.9	242.9
OUTPUT FLOW (L/MIN)	51.46	21.40	73.43	127.85	179.04	228.88	281.82
INPUT POWER (KW)	58.50	37.52	58.50	58.50	58.50	58.50	58.50
SYS. PRESSURE (BAR)	414.00	414.00	341.85	227.93	169.69	132.63	108.87
VOLUMETRIC EFFICIENCY	67.52	46.24	9.10	91.39	95.35	96.70	98.19
TORSIONAL EFFICIENCY	89.88	85.15	90.42	90.85	90.77	89.43	89.02
OVERALL EFFICIENCY	60.69	39.37	71.52	83.02	86.55	86.48	87.41

MOTOR PERFORMANCE FOR MODEL 6431

	18.00	18.00	18.00	18.00	18.00	18.00	18.00
SWASH ANGLE (DEG.)	18.00	18.00	18.00	18.00	18.00	18.00	18.00
DISPLACEMENT (CU.CM.)	105.3852	105.3852	105.3852	105.3852	105.3852	105.3852	105.3852
OUTPUT SPEED (RPM)	415.54	142.26	635.03	1172.39	1664.00	2139.48	2643.75
OUTPUT TORQUE (N.M)	662.4	652.4	547.2	364.7	266.6	201.6	158.3
OUTPUT FLOW (L/MIN)	43.79	14.99	66.92	123.55	175.36	225.47	278.61
OUTPUT POWER (KW)	28.82	9.72	36.39	44.78	46.45	45.17	43.82
VOLUMETRIC EFFICIENCY	85.11	70.04	91.13	96.64	97.95	98.51	98.86
TORSIONAL EFFICIENCY	95.39	93.95	95.44	95.41	93.66	90.64	86.67
OVERALL EFFICIENCY	81.18	65.81	86.98	92.20	91.73	89.28	85.69
PUMP&MTR. EFFICIENCY	49.27	25.91	62.21	76.54	79.40	77.22	74.90
HYD.TRAN. EFFICIENCY	48.04	24.91	60.65	74.63	77.42	75.29	73.03

WINCH PERFORMANCE

OUTPUT TORQUE(N.M)	34167.	33654.	28228.	18814.	13750.	10401.	8164.
OUTPUT SPEED (RPM)	7.7	2.6	11.7	21.6	30.6	39.4	48.7
LINE VELOCITY (M/S)	.315	.108	.481	.887	1.260	1.619	2.001
LINE PULL (N)	87051.	85742.	71919.	47935.	35033.	26498.	20801.

GEAR RATIO = 54.30 GEAR EFFICIENCY 95.00 DRUM RADIUS(MM) = 392.50

EATON CORP.
 HYDRAULICS DIVISION
 15151 HIGHWAY 5
 EDEN PRAIRIE, MN 55344, USA

THIS DATA IS A PERFORMANCE PREDICTION BASED ON GENERAL EMPIRICAL FORMULAS FOR THE GIVEN APPLICATION INFORMATION. IT DOES NOT CONSTITUTE APPLICATION APPROVAL OR ASSURANCE OF SIMILAR RESULTS FOR ANY PARTICULAR EQUIPMENT.

DATE: 12/19/1997

TITLE: ABC WINCH G.m.b.H. Winch Drive

PUMP MODEL	MOTOR MODEL	NO. OF MOTORS	RELIEF PRESS(BAR)	CHARGE PUMP PRESS(BAR)	CHARGE PUMP LOSS(KW)
7620	6431	1	414.0	11.0	1.50

AVAILABLE TRANSMISSION INPUT POWER 60.00 KW

PUMP PERFORMANCE FOR MODEL 7620

	4.93	3.00	6.00	9.00	12.00	15.00	18.00
SWASH ANGLE (DEG.)	4.93	3.00	6.00	9.00	12.00	15.00	18.00
DISPLACEMENT (CU.CM.)	33.1325	20.1276	40.3661	60.8288	81.6339	102.9077	124.7875
INPUT SPEED (RPM)	2300.	2300.	2300.	2300.	2300.	2300.	2300.
INPUT TORQUE (N.M)	242.9	155.8	242.9	242.9	242.9	242.9	242.9
OUTPUT FLOW (L/MIN)	51.46	21.40	73.43	127.85	179.04	228.88	281.82
INPUT POWER (KW)	58.50	37.52	58.50	58.50	58.50	58.50	58.50
SYS. PRESSURE (BAR)	414.00	414.00	341.85	227.93	169.69	132.63	108.87
VOLUMETRIC EFFICIENCY	67.52	46.24	9.10	91.39	95.35	96.70	98.19
TORSIONAL EFFICIENCY	89.88	85.15	90.42	90.85	90.77	89.43	89.02
OVERALL EFFICIENCY	60.69	39.37	71.52	83.02	86.55	86.48	87.41

MOTOR PERFORMANCE FOR MODEL 6431

	18.00	18.00	18.00	18.00	18.00	18.00	18.00
SWASH ANGLE (DEG.)	18.00	18.00	18.00	18.00	18.00	18.00	18.00
DISPLACEMENT (CU.CM.)	105.3852	105.3852	105.3852	105.3852	105.3852	105.3852	105.3852
OUTPUT SPEED (RPM)	415.54	142.26	635.03	1172.39	1664.00	2139.48	2643.75
OUTPUT TORQUE (N.M)	662.4	652.4	547.2	364.7	266.6	201.6	158.3
OUTPUT FLOW (L/MIN)	43.79	14.99	66.92	123.55	175.36	225.47	278.61
OUTPUT POWER (KW)	28.82	9.72	36.39	44.78	46.45	45.17	43.82
VOLUMETRIC EFFICIENCY	85.11	70.04	91.13	96.64	97.95	98.51	98.86
TORSIONAL EFFICIENCY	95.39	93.95	95.44	95.41	93.66	90.64	86.67
OVERALL EFFICIENCY	81.18	65.81	86.98	92.20	91.73	89.28	85.69
PUMP&MTR. EFFICIENCY	49.27	25.91	62.21	76.54	79.40	77.22	74.90
HYD.TRAN. EFFICIENCY	48.04	24.91	60.65	74.63	77.42	75.29	73.03

WINCH PERFORMANCE

OUTPUT TORQUE(N.M)	34167.	33654.	28228.	18814.	13750.	10401.	8164.
OUTPUT SPEED (RPM)	7.7	2.6	11.7	21.6	30.6	39.4	48.7
LINE VELOCITY (M/S)	.234	.080	.358	.661	.939	1.207	1.491
LINE PULL (N)	116812.	115056.	64323.	64323.	47010.	35558.	27913.

GEAR RATIO = 54.30 GEAR EFFICIENCY 95.00 DRUM RADIUS(MM) = 292.50

Combines GmbH Calculations

The final drive is specified; therefore, calculation of a P.R. is not necessary. Find the motor torque to spin drive wheels.

$$\begin{aligned} T.E.s &= (Wda) (\mu) \\ &= (10,500) (9,81) (.7) \quad \text{Note: 1 Kgf} = 9,81 \\ &\quad \text{Newtons} \\ &= 72103,5 \text{ Newtons} \end{aligned}$$

$$\begin{aligned} T_w &= (T.E.s) (L.R.) \\ &= (72103,5) (0,714) \\ &= 51482 \text{ N-m} \end{aligned}$$

$$\begin{aligned} T_m &= \frac{T_w}{(FDR)(Er)} \\ &= \frac{51482}{(100) (.85)} \end{aligned}$$

$$= 606 \text{ N-m}$$

Check the tractive effort and motor torque to ascend a 35% grade in 2nd gear.

$$\begin{aligned} G &= 35\% \\ q &= \tan^{-1} (35/100) \\ q &= 19.29^\circ \end{aligned}$$

$$T.E.g = GVW \sin \theta + RR \cos \theta$$

$$\text{Note: } RR = rGVW$$

$$T.E.g = (18000) (9.81) \sin 19.29 + (18000) (9.81) (.05) \cos 19.29$$

$$T.E.g = 66667 \text{ Newtons}$$

The tractive effort is less than required to slip the wheels in 2nd gear. Therefore, we can use a model 64 MF.

Pump Selection

$$Nm = \frac{(Vs)(FDR)(2,65)}{L.R.}$$

$$Vs = 13 \text{ Kph, FDR} = 60:1 \text{ In 3rd gear}$$

$$Vs = 25 \text{ Kph, FDR} = 30:1 \text{ In 4th gear}$$

$$Nm = \frac{(13)(60)(2,65)}{0,714} = 2895 \text{ rpm}$$

$$Nm = \frac{(25)(30)(2,65)}{0,714}$$

Therefore, use 2895 RPM to size the pump.

$$\begin{aligned} D_p &= \frac{(Nm)(D_m)}{(N_p)(E_{vp})(E_{vm})} \\ &= \frac{(2895)(105.4)}{(2990)(.96)(.97)} \end{aligned}$$

$$= 109.6 \text{ cc}$$

Therefore, use a 64 PV.

$$Nm_{max} = \frac{(D_p)(N_e)(E_{os})(IDR)}{(D_m)(E_{vp})(E_{vm})}$$

Overspeed Calculations

$$Nm_{max} = \frac{(105.4) (2300) (1.17)(1.3)}{(105.4) (.96) (.97)}$$

$$= 3757 \text{ rpm}$$

This speed is above the limit for a model 64 motor
This is OK.

Power Limiting Pressure

$$T_p = \frac{(P_i) (9549,3) (E_{ir})}{(N_e) (IDR)}$$

$$= \frac{(60) (9549,3) (.98)}{(2300) (1.3)}$$

$$= 187,8 \text{ N-m}$$

$$P = \frac{(T_p)(20\pi)(E_{tp})}{D_p}$$

$$= \frac{(187,8)(20\pi)(.95)}{105,4}$$

$$= 106 \text{ Bar @ 60 Kw input}$$

$$P = 106 \times \frac{140}{60}$$

$$= 106 \text{ Bar @ 60 Kw input}$$

$$= 248 \text{ Bar @ 140 Kw input}$$

This pressure is okay.

Heavy Duty Hydrostatic Transmission



Application Data Sheet

Light / Medium / Heavy Duty Hydrostatic Transmission
Eaton Corporation Hydraulics Division 15151 Highway 5 Eden Prairie MN 55344

Date: 21/8/89
Application No. 102A
MPS/EP No. _____

Company Name Combines G.m.b.H Completed By Roger Benkovic

Address _____

City _____ Phone No. _____

State _____ Zip _____ Contact _____

MOBILE APPLICATION

Vehicle Description Combine

Vehicle Weight: Net 12500 kg Gross 18000 kg Max. Weight on Drive Wheels 10500 kg

Vehicle Ground Speed: Working Range 13 Kph MPH

Road Range 25 Kph MPH

Max. Desired Gradeability 35 %; Max. Desired Drawbar or Tractive Effort Spin Wheels in 2nd Range on Dirt

Coefficient of Traction (adhesion) .7

Coefficient of Rolling Resistance .15 mud; .025 transport; .05 field

Rolling Radius (include optional tires) 714 mm

Vehicle Accessories: Trailers Wheel Weights Other (describe) Gradeability Requirement is for 2nd range
To Complete See Reverse Side

NON MOBILE APPLICATION

Description of Application _____

Output Torque Required from Transmission: Continuous _____ Maximum

Output Speed Required from Transmission: Minimum _____ Maximum

To Complete See Reverse Side—

WINCH APPLICATION

Drum Diameter _____ Drum RPM Maximum _____

Line Pull Required _____ lbs

Line Speed: Feet per Minute Maximum _____

Cable Diameter Inches _____ Nestled Cable Diameter

Cable Wraps _____

POWER SOURCE

Gas Diesel Electric Make and Model No. _____
Horsepower Rating (@ Full Loaded Governed Speed) 150 Kw @ 2300 RPM

PUMP INPUT

Input Rotation (Facing Input Drive Shaft): CW CCW

Input Drive: Belt Chain Direct/Coupling

Input Drive Ratio 1.3:1

Normal Input Horsepower 60 Kw Input RPM 2990

Maximum Input Horsepower 140 Kw Input RPM 2990

MOTOR OUTPUT

Output Drive: Belt Chain Direct/Coupling Axle

Multispeed Gear Box Ratios 1st 200 2nd 100 3 rd 60 4th 30

Axle or Final Drive Ratio _____ Drive Ratio Efficiency 85 %

Eaton to select final drive ratio

CONTROL INPUT

Hand Lever Foot Pedal Other (describe) cable

DUTY CYCLE:

Describe Operating Conditions (% time) 35% less than 150 bar, 30% 150 - 200 bar;
25% 200 - 300 bar;5% 300 - 350 bar; 5% 350 - 414 bar

EATON CORP.
 HYDRAULICS DIVISION
 15151 HIGHWAY 5
 EDEN PRAIRIE, MN 55344, USA

THIS DATA IS A PERFORMANCE PREDICTION BASED ON GENERAL EMPIRICAL FORMULAS FOR THE GIVEN APPLICATION INFORMATION. IT DOES NOT CONSTITUTE APPLICATION APPROVAL OR ASSURANCE OF SIMILAR RESULTS FOR ANY PARTICULAR EQUIPMENT.

DATE: 12/19/1997

TITLE: COMBINES G.m.b.H.

PUMP MODEL	MOTOR MODEL	NO. OF MOTORS	RELIEF PRESS (BAR)	CHARGE PRESS(BAR)	CHARGE PUMP LOSS(KW)
6421	6431	1	414.0	11.0	1.20

AVAILABLE TRANSMISSION INPUT POWER 60.00 KW

PUMP PERFORMANCE FOR MODEL 6421

SWASH ANGLE (DEG.)	4.37	3.00	6.00	9.00	12.00	15.00	18.00
DISPLACEMENT (CU.CM.)	24.7756	16.9981	34.0899	51.3710	68.9841	86.9074	105.3852
INPUT SPEED (RPM)	2990.	2990.	2990.	2990.	2990.	2990.	2990.
INPUT TORQUE (N.M)	187.8	135.2	187.8	187.8	187.8	187.8	187.8
OUTPUT FLOW (L/MIN)	45.40	21.99	82.45	141.87	197.19	252.21	309.97
INPUT POWER (KW)	58.80	42.32	58.80	58.80	58.80	58.80	58.80
SYS. PRESSURE (BAR)	414.00	414.00	305.50	202.55	150.67	116.72	95.59
VOLUMETRIC EFFICIENCY	61.29	43.27	80.99	92.37	95.66	97.06	98.37
TORSIONAL EFFICIENCY	86.93	82.87	88.26	88.18	88.04	85.97	85.37
OVERALL EFFICIENCY	53.28	35.86	71.39	81.45	84.22	83.44	83.98

MOTOR PERFORMANCE FOR MODEL 6431

SWASH ANGLE (DEG.)	18.00	18.00	18.00	18.00	18.00	18.00	18.00
DISPLACEMENT (CU.CM.)	105.3852	105.3852	105.3852	105.3852	105.3852	105.3852	105.3852
OUTPUT SPEED (RPM)	360.49	147.60	728.02	1311.04	1837.95	2362.84	2913.07
OUTPUT TORQUE (N.M)	661.2	652.7	489.1	322.9	233.8	173.6	134.1
OUTPUT FLOW (L/MIN)	37.99	15.56	76.72	138.16	193.69	249.01	306.99
OUTPUT POWER (KW)	24.96	10.09	37.29	44.33	45.00	42.94	40.90
VOLUMETRIC EFFICIENCY	83.68	70.73	93.06	97.39	98.26	98.73	99.04
TORSIONAL EFFICIENCY	95.22	94.00	95.45	95.05	92.53	88.65	83.63
OVERALL EFFICIENCY	79.68	66.49	88.83	92.56	90.89	87.53	82.83
PUMP&MTR. EFFICIENCY	42.45	23.84	63.42	75.39	76.54	73.03	69.56
HYD.TRAN. EFFICIENCY	41.60	23.18	62.15	73.89	75.01	71.57	68.17

VEHICLE PERFORMANCE

TRACTIVE EFFORT (N)	47228.	46625.	34936.	23064.	16702.	12396.	9577.
VEHICLE SPEED (KM/H)	1.62	.66	3.27	5.88	8.25	10.60	13.07
DRAWBAR PULL (N)	38402.	37799.	26110.	14238.	7876.	3570.	751.
DRAWBAR POWER (KW)	17.25	6.25	23.69	23.26	18.04	10.51	2.73
GRADEABILITY	22.53	22.17	15.12	8.22	4.54	2.09	.52

GEAR RATIO OR FDR = 60.00
 LOAD RADIUS(MM) = 714.00

GEAR EFF.= 85.00
 ROLL RES.COEFF.= .05

VEHICLE WT. (KG) = 18000.
 ROLLING RES. (N) = 8826.

EATON CORP.
 HYDRAULICS DIVISION
 15151 HIGHWAY 5
 EDEN PRAIRIE, MN 55344, USA

THIS DATA IS A PERFORMANCE PREDICTION BASED ON GENERAL EMPIRICAL FORMULAS FOR THE GIVEN APPLICATION INFORMATION. IT DOES NOT CONSTITUTE APPLICATION APPROVAL OR ASSURANCE OF SIMILAR RESULTS FOR ANY PARTICULAR EQUIPMENT.

DATE: 12/19/1997

TITLE: COMBINES G.m.b.H.

PUMP MODEL	MOTOR MODEL	NO. OF MOTORS	RELIEF PRESS (BAR)	CHARGE PRESS(BAR)	CHARGE PUMP LOSS(KW)
6421	6431	1	414.0	11.0	1.20

AVAILABLE TRANSMISSION INPUT POWER 140.00 KW

PUMP PERFORMANCE FOR MODEL 6421

SWASH ANGLE (DEG.)	11.0	3.00	6.00	9.00	12.00	15.00	18.00
DISPLACEMENT (CU.CM.)	63.0173	16.9981	34.0899	51.3710	68.9413	86.9074	105.3852
INPUT SPEED (RPM)	2990.	2990.	2990.	2990.	2990.	2990.	2990.
INPUT TORQUE (N.M)	443.3	135.2	249.9	364.1	443.3	443.3	443.3
OUTPUT FLOW (L/MIN)	161.65	21.99	73.32	124.40	182.69	239.91	300.76
INPUT POWER (KW)	138.80	42.32	78.24	114.01	138.80	138.80	138.80
SYS. PRESSURE (BAR)	414.00	414.00	414.00	414.00	378.21	298.13	246.30
VOLUMETRIC EFFICIENCY	85.79	43.27	71.94	80.99	88.63	92.33	95.45
TORSIONAL EFFICIENCY	93.67	82.87	89.89	92.96	82.97	85.88	85.37
OVERALL EFFICIENCY	53.28	35.86	71.39	81.45	84.22	83.44	88.95

MOTOR PERFORMANCE FOR MODEL 6431

SWASH ANGLE (DEG.)	18.00	18.00	18.00	18.00	18.00	18.00	18.00
DISPLACEMENT (CU.CM.)	105.3852	105.3852	105.3852	105.3852	105.3852	105.3852	105.3852
OUTPUT SPEED (RPM)	1478.58	147.60	614.41	1078.85	1622.80	2181.54	2769.55
OUTPUT TORQUE (N.M)	667.0	652.7	665.3	667.5	607.5	471.7	382.7
OUTPUT FLOW (L/MIN)	149.39	15.56	64.75	113.69	171.02	229.90	291.87
OUTPUT POWER (KW)	99.01	10.09	42.81	75.42	103.16	107.76	110.99
VOLUMETRIC EFFICIENCY	83.68	70.73	93.06	97.39	98.26	98.73	99.04
TORSIONAL EFFICIENCY	92.42	94.00	95.82	96.13	95.69	94.33	92.64
OVERALL EFFICIENCY	88.77	66.49	84.61	87.86	89.58	90.40	89.90
PUMP&MTR. EFFICIENCY	71.33	23.84	54.72	66.15	74.32	77.64	79.96
HYD. TRAN. EFFICIENCY	70.72	23.18	53.89	65.46	73.68	76.97	79.28

VEHICLE PERFORMANCE

TRACTIVE EFFORT (N)	79402.	77708.	79208.	79470.	72264.	56155.	45558.
VEHICLE SPEED (KM/H)	3.82	.40	1.65	2.90	4.37	5.87	7.45
DRAWBAR PULL (N)	70576.	68882.	70382.	70644.	63438.	47329	36732.
DRAWBAR POWER (KW)	74.80	7.60	32.33	56.98	76.97	77.20	76.06
GRADEABILITY	44.31	43.06	44.10	44.31	38.99	28.11	21.44

GEAR RATIO OR FDR = 100.00
 LOAD RADIUS(MM) = 714.00

GEAR EFF.= 85.00
 ROLL RES.COEFF.= .05

VEHICLE WT. (KG) = 18000.
 ROLLING RES. (N) = 8826.

EATON CORP.
 HYDRAULICS DIVISION
 15151 HIGHWAY 5
 EDEN PRAIRIE, MN 55344, USA

THIS DATA IS A PERFORMANCE PREDICTION BASED ON GENERAL EMPIRICAL FORMULAS FOR THE GIVEN APPLICATION INFORMATION. IT DOES NOT CONSTITUTE APPLICATION APPROVAL OR ASSURANCE OF SIMILAR RESULTS FOR ANY PARTICULAR EQUIPMENT.

DATE: 12/19/1997

TITLE: COMBINES G.m.b.H.

PUMP MODEL	MOTOR MODEL	NO. OF MOTORS	RELIEF PRESS (BAR)	CHARGE PRESS(BAR)	CHARGE PUMP LOSS(KW)
6421	6431	1	414.0	11.0	1.20

AVAILABLE TRANSMISSION INPUT POWER 60.00 KW

PUMP PERFORMANCE FOR MODEL 6421

	4.37	3.00	6.00	9.00	12.00	15.00	18.00
SWASH ANGLE (DEG.)	4.37	3.00	6.00	9.00	12.00	15.00	18.00
DISPLACEMENT (CU.CM.)	24.7756	16.9981	34.0899	51.3710	68.9841	86.9074	105.3852
INPUT SPEED (RPM)	2990.	2990.	2990.	2990.	2990.	2990.	2990.
INPUT TORQUE (N.M)	187.8	135.2	187.8	187.8	187.8	187.8	187.8
OUTPUT FLOW (L/MIN)	45.40	21.99	82.45	141.87	197.19	252.21	309.97
INPUT POWER (KW)	58.80	42.32	58.80	58.80	58.80	58.80	58.80
SYS. PRESSURE (BAR)	414.00	414.00	305.50	202.55	150.67	116.72	95.59
VOLUMETRIC EFFICIENCY	61.29	43.27	80.99	92.37	95.66	97.06	98.37
TORSIONAL EFFICIENCY	86.93	82.87	88.26	88.18	88.04	85.97	85.37
OVERALL EFFICIENCY	53.28	35.86	71.39	81.45	84.22	83.44	83.98

MOTOR PERFORMANCE FOR MODEL 6431

	18.00	18.00	18.00	18.00	18.00	18.00	18.00
SWASH ANGLE (DEG.)	18.00	18.00	18.00	18.00	18.00	18.00	18.00
DISPLACEMENT (CU.CM.)	105.3852	105.3852	105.3852	105.3852	105.3852	105.3852	105.3852
OUTPUT SPEED (RPM)	360.49	147.60	728.02	1311.04	1837.95	2362.84	2913.07
OUTPUT TORQUE (N.M)	661.2	652.7	489.1	322.9	233.8	173.6	134.1
OUTPUT FLOW (L/MIN)	37.99	15.56	76.72	138.16	193.69	249.01	306.99
OUTPUT POWER (KW)	24.96	10.09	37.29	44.33	45.00	42.94	40.90
VOLUMETRIC EFFICIENCY	83.68	70.73	93.06	97.39	98.26	98.73	99.04
TORSIONAL EFFICIENCY	95.22	94.00	95.45	95.05	92.53	88.65	83.63
OVERALL EFFICIENCY	79.68	66.49	88.83	92.56	90.89	87.53	82.83
PUMP&MTR. EFFICIENCY	42.45	23.84	63.42	75.39	76.54	73.03	69.56
HYD.TRAN. EFFICIENCY	41.60	23.18	62.15	73.89	75.01	71.57	68.17

VEHICLE PERFORMANCE

	23614.	23312.	17468.	11532.	8351.	6198.	4789.
TRACTIVE EFFORT (N)	23614.	23312.	17468.	11532.	8351.	6198.	4789.
VEHICLE SPEED (KM/H)	3.23	1.32	6.53	11.76	16.49	21.20	26.14
DRAWBAR PULL (N)	19937.	19635.	13790.	7855.	4673.	2521.	1111.
DRAWBAR POWER (KW)	17.91	7.22	25.02	25.67	21.41	14.84	8.07
GRADEABILITY	16.55	16.37	11.39	6.47	3.84	2.09	1.05

GEAR RATIO OR FDR = 30.00
 LOAD RADIUS(MM) = 714.00

GEAR EFF.= 85.00
 ROLL RES.COEFF.= .03

VEHICLE WT. (KG) = 12500.
 ROLLING RES. (N) = 3677.

EATON CORP.
 HYDRAULICS DIVISION
 15151 HIGHWAY 5
 EDEN PRAIRIE, MN 55344 USA

THIS DATA IS A PERFORMANCE PREDICTION BASED ON GENERAL EMPIRICAL FORMULAS FOR THE GIVEN APPLICATION INFORMATION. IT DOES NOT CONSTITUTE APPLICATION APPROVAL OR ASSURANCE OF SIMILAR RESULTS FOR ANY PARTICULAR EQUIPMENT.

DATE: 12/19/1997

TITLE: COMBINES G.m.b.H.

PUMP MODEL	MOTOR MODEL	NO. OF MOTORS	RELIEF PRESS(BAR)	CHARGE PRESS (BAR)	CHARGE PUMP LOSS(kw)
6421	6431	1	414.0	11.0	1.20

AVAILABLE TRANSMISSION INPUT POWER 140.00 KW

PUMP PERFORMANCE FOR MODEL 6421

	11.00	3.00	6.00	9.00	12.00	15.00	18.00
SWASH ANGLE (DEG.)	11.00	3.00	6.00	9.00	12.00	15.00	18.00
DISPLACEMENT (CU.CM.)	63.0173	16.9981	34.0899	51.3710	68.9413	86.9074	105.3852
INPUT SPEED (RPM)	2990.	2990.	2990.	2990.	2990.	2990.	2990.
INPUT TORQUE (N.M)	443.3	135.2	250.0	364.3	43.3	443.3	443.3
OUTPUT FLOW (L/MIN)	161.65	21.99	73.32	124.40	182.69	239.91	300.76
INPUT POWER (KW)	138.80	42.35	78.24	114.01	138.80	138.80	138.80
SYS. PRESSURE (BAR)	414.00	414.00	414.00	414.00	378.21	298.13	246.30
VOLUMETRIC EFFICIENCY	85.76	43.27	71.94	80.99	88.64	92.33	95.45
TORSIONAL EFFICIENCY	93.57	82.87	89.89	92.96	93.61	93.02	93.19
OVERALL EFFICIENCY	80.36	35.86	64.67	75.29	82.97	85.88	88.95

MOTOR PERFORMANCE FOR MODEL 6431

	18.00	18.00	18.00	18.00	18.00	18.00	18.00
SWASH ANGLE (DEG.)	18.00	18.00	18.00	18.00	18.00	18.00	18.00
DISPLACEMENT (CU.CM.)	105.3852	105.3852	105.3852	105.3852	105.3852	105.3852	105.3852
OUTPUT SPEED (RPM)	1417.58	147.60	614.41	1078.85	1622.80	2181.54	2769.55
OUTPUT TORQUE (N.M)	667.0	652.7	665.3	667.5	607.0	471.7	382.7
OUTPUT FLOW (L/MIN)	149.39	15.56	64.75	113.69	171.02	229.90	291.87
OUTPUT POWER (KW)	99.01	10.09	42.81	75.42	103.16	107.76	110.99
VOLUMETRIC EFFICIENCY	92.42	70.73	88.31	91.40	93.61	95.83	97.05
TORSIONAL EFFICIENCY	96.05	94.00	95.82	96.13	95.69	94.33	92.64
OVERALL EFFICIENCY	88.77	66.49	84.61	87.86	89.58	90.40	89.90
PUMP&MTR. EFFICIENCY	71.33	23.84	54.72	66.15	74.32	77.64	79.96
HYD.TRAN. EFFICIENCY	70.72	23.18	53.89	65.46	73.68	76.97	79.28

VEHICLE PERFORMANCE

TRACTIVE EFFORT (N)	47641.	46625.	47525.	47682.	43358.	33693.	27335.
VEHICLE SPEED (KM/H)	6.36	.66	2.76	4.84	7.28	9.79	1242
DRAWBAR PULL (N)	38815.	37799.	38699.	38856.	34532.	24867.	18509.
DRAWBAR POWER (KW)	68.57	6.95	29.63	52.25	69.83	67.60	63.88
GRADEABILITY	22.72	22.17	22.72	22.72	20.16	14.41	10.69

GEAR RATIO OR FDR= 60.00
 LOAD RADIUS(MM) = 714.00

GEAR EFF.= 85.00
 ROLL RES.COEFF.= .05

VEHICLE WT. (KG) = 18000.
 ROLLING RES. (N) = 8826.

EATON CORP.
 HYDRAULICS DIVISION
 15151 HIGHWAY 5
 EDEN PRAIRIE, MN 55344 USA

THIS DATA IS A PERFORMANCE PREDICTION BASED ON GENERAL EMPIRICAL FORMULAS FJR THE GIVEN APPLICATION INFORMATION. IT DOES NOT CONSTITUTE APPLICATION APPROVAL OR ASSURANCE OF SIMILAR RESULTS FOR ANY PARTICULAR EQUIPMENT.

DATE: 12/19/1997

TITLE: COMBINES G.m.b.H.

PUMP MODEL	MOTOR MODEL	NO. OF MOTORS	RELIEF PRESS(BAR)	CHARGE PRESS (BAR)	CHARGE PUMP LOSS(kW)
6421	6431	1	414.0	11.0	1.20

AVAILABLE TRANSMISSION INPUT POWER 140.00 KW

PUMP PERFORMANCE FOR MODEL 6421

SWASH ANGLE (DEG.)	11.00	3.00	6.00	9.00	12.00	15.00	18.00
DISPLACEMENT (CU.CM.)	63.0173	16.9981	34.0899	51.3710	68.9413	86.9074	105.3852
INPUT SPEED (RPM)	2990.	2990.	2990.	2990.	2990.	2990.	2990.
INPUT TORQUE (N.M)	443.3	135.2	250.0	364.3	43.3	443.3	443.3
OUTPUT FLOW (L/MIN)	161.65	21.99	73.32	124.40	182.69	239.91	300.76
INPUT POWER (KW)	138.80	42.35	78.24	114.01	138.80	138.80	138.80
SYS. PRESSURE (BAR)	414.00	414.00	414.00	414.00	378.21	298.13	246.30
VOLUMETRIC EFFICIENCY	85.76	43.27	71.94	80.99	88.64	92.33	95.45
TORSIONAL EFFICIENCY	93.57	82.87	89.89	92.96	93.61	93.02	93.19
OVERALL EFFICIENCY	80.36	35.86	64.67	75.29	82.97	85.88	88.95

MOTOR PERFORMANCE FOR MODEL 6431

SWASH ANGLE (DEG.)	18.00	18.00	18.00	18.00	18.00	18.00	18.00
DISPLACEMENT (CU.CM.)	105.3852	105.3852	105.3852	105.3852	105.3852	105.3852	105.3852
OUTPUT SPEED (RPM)	1417.58	147.60	614.41	1078.85	1622.80	2181.54	2769.55
OUTPUT TORQUE (N.M)	667.0	652.7	665.3	667.5	607.0	471.7	382.7
OUTPUT FLOW (L/MIN)	149.39	15.56	64.75	113.69	171.02	229.90	291.87
OUTPUT POWER (KW)	99.01	10.09	42.81	75.42	103.16	107.76	110.99
VOLUMETRIC EFFICIENCY	92.42	70.73	88.31	91.40	93.61	95.83	97.05
TORSIONAL EFFICIENCY	96.05	94.00	95.82	96.13	95.69	94.33	92.64
OVERALL EFFICIENCY	88.77	66.49	84.61	87.86	89.58	90.40	89.90
PUMP&MTR. EFFICIENCY	71.33	23.84	54.72	66.15	74.32	77.64	79.96
HYD.TRAN. EFFICIENCY	70.72	23.18	53.89	65.46	73.68	76.97	79.28

VEHICLE PERFORMANCE

TRACTIVE EFFORT (N)	23820.	23312	23762.	23841	21679.	16847.	13667.
VEHICLE SPEED (KM/H)	12.72	1.32	5.51	9.68	14.56	19.57	24.85
DRAWBAR PULL (N)	20143.	19.635	20085.	20163.	182002.	13169.	9990.
DRAWBAR POWER (KW)	71.17	7.22	30.76	54.22	72.81	71.60	68.96
GRADEABILITY	16.73	16.37	16.73	16.73	14.94	10.86	8.22

GEAR RATIO OR FDR= 30.00
 LOAD RADIUS(MM) = 714.00

GEAR EFF.= 85.00
 ROLL RES.COEFF.= .03

VEHICLE WT. (KG) = 12500.
 ROLLING RES. (N) = 3677.

Harvester's Ltd. Calculations

Power Range Calculations

$$Pr_v = \frac{(T.E.s)(Vs)}{(C1)(Er)}$$

$$T.E.s = (Wda)(\mu)$$

$$= (83385)(.7)$$

$$= 58370 \text{ Newtons}$$

$$P.R.v = \frac{(58370)(8)}{(3600)(.9)}$$

$$= 144.1$$

Motor Selection

Try a 46MF

P.R. em = 148

Note: A relief valve setting of 414 bar is permissible because the OEM does not object to this pressure.

Final Drive Ratio Selection

$$Tw = (T.E.) (L.R.)$$

$$= (83385)(.7)(0,734)$$

$$= 42843 \text{ N-m}$$

$$FDR2 = \frac{TW}{(TM)(Er)}$$

$$= \frac{42843}{(471)(.9)}$$

$$= 101.07 : 1$$

$$\text{Axle Ratio} = \frac{FDR2}{\text{Gear Ratio in 2nd}}$$

$$= \frac{101.7}{14.14}$$

$$= 7.15:1$$

$$FDR = (\text{Axle Ratio})(\text{Gear Ratio in 3rd})$$

$$= (7.15)(4.7)$$

$$= 33.6:1$$

Pump Selection

$$Nm = \frac{(Vs)(FDR)(2.65)}{L.R.}$$

$$= \frac{(8)(101.07)(2,65)}{0,734}$$

$$= 2919 \text{ rpm in 2nd Gear}$$

$$Nm = \frac{(25)(33.6)(2,65)}{0,734}$$

$$= 3033 \text{ rpm in 3rd Gear}$$

This speed is greater! Use it.

$$Dp = \frac{(Nm)(Dm)}{(Np)(Evp)(Evm)}$$

$$= \frac{(3033)(75,28)}{(3308)(.96)(.97)}$$

$$= 74.11$$

Therefore, use a 46 PV

Overspeed Calculations

$$Nm \text{ max} = \frac{(Dp)(Ne)(Eos)(IDR)}{(Dm)(Evp)(Evm)}$$

$$Nm \text{ max} = 2900 \text{ rpm (for this given engine)}$$

$$Nm \text{ max} = \frac{(75,28)(2900)(1.35)}{(75,28)(.96)(.97)}$$

$$= 4204 \text{ rpm}$$

This exceeds the 46 MF speed limit by 39 rpm, but this is okay.

$$Np \text{ max} = (Ne \text{ max})(IDR)$$

$$= (2900)(1.35)$$

$$= 3915 \text{ rpm}$$

Power Limiting Pressure

$$Tp = \frac{(Pi)(9549,3)(.98)}{(Ne)(IDR)}$$

$$= \frac{(110)(9549,3)(.98)}{(2450)(1.35)}$$

$$= 311.2 \text{ N-m}$$

$$P = \frac{(Tp)(20\pi)(Etp)}{Dp}$$

$$= (311,2) \text{ N-m}$$

$$= \frac{(311,2)(20\pi)(.95)}{75,28}$$

$$= 247 \text{ bar This pressure should be okay.}$$

Heavy Duty Hydrostatic Transmission



Application Data Sheet

Light / Medium / Heavy Duty Hydrostatic Transmission

Eaton Corporation Hydraulics Division 15151 Highway 5 Eden Prairie MN 55344

Date: 21/8/89

Application No. 103A

MPS/EP No. _____

Company Name _____

Completed By Roger Benkovic

Address _____

City _____ Phone No. _____

State _____ Zip _____ Contact _____

MOBILE APPLICATION

Vehicle Description Pea Combine

Vehicle Weight: Net 10000 K Gross 12500 Kgf Max. Weight on Drive Wheels 8500 Kg

Vehicle Ground Speed: Working Range 8 Kph MPH

Road Range 25 Kph MPH

Max. Desired Gradeability 35%; Max. Desired Drawbar or Tractive Effort Spin Wheels in working range

Coefficient of Traction (adhesion) .7

Coefficient of Rolling Resistance .15 in mud, .05 in the field, .025 transport

Rolling Radius (include optional tires) 734 mm

Vehicle Accessories: Trailers Wheel Weights Other (describe) Gradeability specification is for
To Complete See Reverse Side working range

NON MOBILE APPLICATION

Description of Application _____

Output Torque Required from Transmission: Continuous _____ Maximum _____

Output Speed Required from Transmission: Minimum _____ Maximum _____

To Complete See Reverse Side—

WINCH APPLICATION

Drum Diameter _____ Drum RPM Maximum _____

Line Pull Required _____ lbs

Line Speed: Feet per Minute Maximum _____

Cable Diameter Inches _____ Nestled Cable Diameter _____

Cable Wraps _____

POWER SOURCE

Gas Diesel Electric Make and Model No. _____

Horsepower Rating (@ Full Loaded Governed Speed) 110 Kw @ 2450 RPM

PUMP INPUT

Input Rotation (Facing Input Drive Shaft): CW CCW

Input Drive: Belt Chain Direct/Coupling

Input Drive Ratio 1:35 : 1 increase

Normal Input Horsepower 45 Kw Input RPM 3307.5

Maximum Input Horsepower 108 Kw Input RPM 3307.5

MOTOR OUTPUT

Output Drive: Belt Chain Direct/Coupling Axle

Multispeed Gear Box Ratios 1st 18.57 2nd 14.14 3 rd 4.7 4th _____

Axle or Final Drive Ratio unknown Drive Ratio Efficiency 90

Eaton to select final drive ratio

CONTROL INPUT

Hand Lever Foot Pedal Other (describe) cable

DUTY CYCLE:

Describe Operating Conditions (% time) unknown

EATON CORP.
 HYDRAULICS DIVISION
 15151 HIGHWAY 5
 EDEN PRAIRIE, MN. 55344, USA

THIS DATA IS A PERFORMANCE PREDICTION BASED ON GENERAL EMPIRICAL FORMULAS FOR THE GIVEN APPLICATION INFORMATION. IT DOES NOT CONSTITUTE APPLICATION APPROVAL OR ASSURANCE OF SIMILAR RESULTS FOR ANY PARTICULAR EQUIPMENT.

DATE: 12/19/1997

TITLE: HARVESTER'S LTD.

PUMP MODEL	MOTOR MODEL	NO. OF MOTORS	RELIEF PRESS(BAR)	CHARGE PRESS(BAR)	CHARGE PUMP LOSS(KW)
4621	4631	1	414.0	11.0	1.20

AVAILABLE TRANSMISSION INPUT POWER 108.00 KW

PUMP PERFORMANCE FOR MODEL 4621

	10.70	3.00	6.00	9.00	12.00	15.00	18.00
SWASH ANGLE (DEG.)	10.70	3.00	6.00	9.00	12.00	15.00	18.00
DISPLACEMENT (CU.CM.)	43.7638	12.1427	24.3522	36.6970	49.2484	62.0825	75.2822
INPUT SPEED (RPM)	3308.	3308.	3308.	3308.	3308.	3308.	3308.
INPUT TORQUE (N.M)	308.3	96.4	178.3	260.0	308.3	308.3	308.3
OUTPUT FLOW (L/MIN)	123.69	17.67	58.27	98.70	145.19	190.28	238.20
INPUT POWER (KW)	106.80	33.39	61.82	90.12	106.80	106.80	106.80
SYS. PRESSURE (BAR)	414.00	414.00	414.00	414.00	368.04	290.17	239.61
VOLUMETRIC EFFICIENCY	85.44	43.99	72.33	81.30	89.12	92.65	95.65
TORSIONAL EFFICIENCY	93.53	83.00	89.98	93.00	93.57	93.00	93.12
OVERALL EFFICIENCY	79.91	36.51	65.08	75.62	83.39	86.16	89.07

MOTOR PERFORMANCE FOR MODEL 4631

	18.00	18.00	18.00	18.00	18.00	18.00	18.00
SWASH ANGLE (DEG.)	18.00	18.00	18.00	18.00	18.00	18.00	18.00
DISPLACEMENT (CU.CM.)	75.2822	75.2822	75.2822	75.2822	75.2822	75.2822	75.2822
OUTPUT SPEED (RPM)	1523.35	172.70	689.88	1204.94	1815.90	2430.70	3078.24
OUTPUT TORQUE (N.M)	476.6	466.6	475.3	476.9	421.6	327.7	265.7
OUTPUT FLOW (L/MIN)	114.68	13.00	51.94	90.71	136.70	182.99	231.74
OUTPUT POWER (KW)	76.03	8.44	34.34	60.17	80.17	83.41	85.66
VOLUMETRIC EFFICIENCY	92.72	73.57	89.13	91.91	94.16	96.17	97.29
TORSIONAL EFFICIENCY	96.08	94.07	95.82	96.13	95.61	94.26	92.56
OVERALL EFFICIENCY	89.08	69.21	85.41	88.35	90.02	90.65	90.05
PUMP&MTR. EFFICIENCY	71.19	25.27	55.59	66.81	75.07	78.10	80.20
HYD.TRAN. EFFICIENCY	70.40	24.39	54.53	65.93	74.23	77.24	79.31

VEHICLE PERFORMANCE

	59432.	57187.	59271.	59464.	52574	40864.	33135.
TRACTIVE EFFORT (N)	59432.	57187.	59271.	59464.	52574	40864.	33135.
VEHICLE SPEED (KM/H)	4.14	.47	1.88	3.28	4.94	6.61	8.38
DRAWBAR PULL (N)	53426.	52180.	53265.	53128.	46568.	34858.	27129.
DRAWBAR POWER (KW)	61.51	6.81	27.77	48.69	63.91	64.04	63.12
GRADEABILITY (%)	50.51	48.99	50.29	50.07	42.65	30.57	23.45

GEAR RATIO OR FDR=101.07
 LOAD RADIUS(MM) = 734.00

GEAR EFF.= 90.00
 ROLL RES.COEFF.= .05

VEHICLE WT. (KG) = 12250.
 ROLLING RES. (N) 6007.

EATON CORP.
 HYDRAULICS DIVISION
 15151 HIGHWAY 5
 EDEN PRAIRIE, MN. 55344, USA

THIS DATA IS A PERFORMANCE PREDICTION BASED ON GENERAL EMPIRICAL FORMULAS FOR THE GIVEN APPLICATION INFORMATION. IT DOES NOT CONSTITUTE APPLICATION APPROVAL OR ASSURANCE OF SIMILAR RESULTS FOR ANY PARTICULAR EQUIPMENT.

DATE: 12/19/1997

TITLE: HARVESTER'S LTD.

PUMP MODEL	MOTOR MODEL	NO. OF MOTORS	RELIEF PRESS(BAR)	CHARGE PRESS(BAR)	CHARGE PUMP LOSS(KW)
4621	4631	1	414.0	11.0	1.20

AVAILABLE TRANSMISSION INPUT POWER 108.00 KW

PUMP PERFORMANCE FOR MODEL 4621

	10.70	3.00	6.00	9.00	12.00	15.00	18.00
SWASH ANGLE (DEG.)	10.70	3.00	6.00	9.00	12.00	15.00	18.00
DISPLACEMENT (CU.CM.)	43.7638	12.1427	24.3522	36.6970	49.2484	62.0825	75.2822
INPUT SPEED (RPM)	3308.	3308.	3308.	3308.	3308.	3308.	3308.
INPUT TORQUE (N.M)	308.3	96.4	178.3	260.0	308.3	308.3	308.3
OUTPUT FLOW (L/MIN)	123.69	17.67	58.27	98.70	145.19	190.28	238.20
INPUT POWER (KW)	106.80	33.39	61.82	90.12	106.80	106.80	106.80
SYS. PRESSURE (BAR)	414.00	414.00	414.00	414.00	368.04	290.17	239.61
VOLUMETRIC EFFICIENCY	85.44	43.99	72.33	81.30	89.12	92.65	95.65
TORSIONAL EFFICIENCY	93.53	83.00	89.98	93.00	93.57	93.00	93.12
OVERALL EFFICIENCY	79.91	36.51	65.08	75.62	83.39	86.16	89.07

MOTOR PERFORMANCE FOR MODEL 4631

	18.00	18.00	18.00	18.00	18.00	18.00	18.00
SWASH ANGLE (DEG.)	18.00	18.00	18.00	18.00	18.00	18.00	18.00
DISPLACEMENT (CU.CM.)	75.2822	75.2822	75.2822	75.2822	75.2822	75.2822	75.2822
OUTPUT SPEED (RPM)	1523.35	172.70	689.88	1204.94	1815.90	2430.70	3078.24
OUTPUT TORQUE (N.M)	476.6	466.6	475.3	476.9	421.6	327.7	265.7
OUTPUT FLOW (L/MIN)	114.68	13.00	51.94	90.71	136.70	182.99	231.74
OUTPUT POWER (KW)	76.03	8.44	34.34	60.17	80.17	83.41	85.66
VOLUMETRIC EFFICIENCY	92.72	73.57	89.13	91.91	94.16	96.17	97.29
TORSIONAL EFFICIENCY	96.08	94.07	95.82	96.13	95.61	94.26	92.56
OVERALL EFFICIENCY	89.08	69.21	85.41	88.35	90.02	90.65	90.05
PUMP&MTR. EFFICIENCY	71.19	25.27	55.59	66.81	75.07	78.10	80.20
HYD.TRAN. EFFICIENCY	70.40	24.39	54.53	65.93	74.23	77.24	79.31

VEHICLE PERFORMANCE

	19635.	19224.	19582.	19646.	17370.	13501.	10947.
TRACTIVE EFFORT (N)	19635.	19224.	19582.	19646.	17370.	13501.	10947.
VEHICLE SPEED (KM/H)	12.55	1.42	5.68	9.92	14.95	20.02	25.35
DRAWBAR PULL (N)	16693.	16282.	16640.	16704.	14428.	10559.	8005.
DRAWBAR POWER (KW)	58.17	6.43	26.26	46.04	59.93	58.71	56.37
GRADEABILITY (%)	17.45	16.91	17.27	17.45	14.94	10.86	8.22

GEAR RATIO OR FDR= 33.60
 LOAD RADIUS(MM) = 734.00

GEAR EFF.= 90.00
 ROLL RES.COEFF.= .03

VEHICLE WT. (KG) = 10000.
 ROLLING RES. (N) 2942..

EATON CORP.
 HYDRAULICS DIVISION
 15151 HIGHWAY 5
 EDEN PRAIRIE, MN. 55344, USA

THIS DATA IS A PERFORMANCE PREDICTION BASED ON GENERAL EMPIRICAL FORMULAS FOR THE GIVEN APPLICATION INFORMATION. IT DOES NOT CONSTITUTE APPLICATION APPROVAL OR ASSURANCE OF SIMILAR RESULTS FOR ANY PARTICULAR EQUIPMENT.

DATE: 12/19/1997

TITLE: HARVESTER'S LTD.

PUMP MODEL	MOTOR MODEL	NO. OF MOTORS	RELIEF PRESS(BAR)	CHARGE PRESS(BAR)	CHARGE PUMP LOSS(KW)
4621	4631	1	414.0	11.0	1.20

AVAILABLE TRANSMISSION INPUT POWER 45.00 KW

PUMP PERFORMANCE FOR MODEL 4621

SWASH ANGLE (DEG.)	4.10	3.00	6.00	9.00	12.00	15.00	18.00
DISPLACEMENT (CU.CM.)	16.6264	12.1427	24.3522	36.6970	49.2484	62.0825	75.2822
INPUT SPEED (RPM)	3308.	3308.	3308.	3308.	3308.	3308.	3308.
INPUT TORQUE (N.M)	126.4	96.4	126.4	126.4	126.4	126.4	126.4
OUTPUT FLOW (L/MIN)	32.62	17.67	66.59	113.02	156.54	200.02	254.54
INPUT POWER (KW)	43.80	33.39	43.80	43.80	43.80	43.80	43.80
SYS. PRESSURE (BAR)	414.00	414.00	287.02	189.92	141.20	109.41	89.34
VOLUMETRIC EFFICIENCY	59.30	43.99	82.67	93.10	96.09	97.39	98.60
TORSIONAL EFFICIENCY	86.64	83.00	87.98	87.73	87.53	85.50	84.66
OVERALL EFFICIENCY	51.38	36.51	72.73	81.67	84.11	83.27	83.47

MOTOR PERFORMANCE FOR MODEL 4631

SWASH ANGLE (DEG.)	18.00	18.00	18.00	18.00	18.00	18.00	18.00
DISPLACEMENT (CU.CM.)	75.2822	75.2822	75.2822	75.2822	75.2822	75.2822	75.2822
OUTPUT SPEED (RPM)	1363.11	172.70	833.30	11466.97	2047.47	2628.41	3235.85
OUTPUT TORQUE (N.M)	471.6	466.6	328.0	215.8	155.9	115.4	88.5
OUTPUT FLOW (L/MIN)	27.34	13.00	62.73	110.44	154.14	197.87	243.60
OUTPUT POWER (KW)	17.93	8.44	28.63	33.15	33.43	31.78	30.00
VOLUMETRIC EFFICIENCY	83.81	73.57	94.20	97.72	98.47	98.93	99.21
TORSIONAL EFFICIENCY	95.08	94.07	95.39	94.83	92.16	88.07	82.70
OVERALL EFFICIENCY	79.68	69.21	89.86	92.66	90.75	87.12	82.05
PUMP&MTR. EFFICIENCY	40.94	25.27	65.36	75.68	76.33	72.55	68.49
HYD.TRAN. EFFICIENCY	39.85	24.39	63.61	73.66	74.29	70.61	66.66

VEHICLE PERFORMANCE

TRACTIVE EFFORT (N)	58810.	58187.	40907.	26908.	19444.	14396.	11039.
VEHICLE SPEED (KM/H)	.99	.47	2.27	3.99	5.57	7.15	8.80
DRAWBAR PULL (N)	52804.	52180.	34900.	20901.	13437.	8389.	5032.
DRAWBAR POWER (KW)	14.39	6.81	21.98	23.17	20.79	16.67	12.31
GRADEABILITY (%)	49.85	48.99	30.76	17.81	11.39	7.17	4.37

GEAR RATIO OR FDR= 101.70
 LOAD RADIUS(MM) = 734.00

GEAR EFF.= 90.00
 ROLL RES.COEFF.= .05

VEHICLE WT. (KG) = 12250.
 ROLLING RES. (N) 6007.

EATON CORP.
 HYDRAULICS DIVISION
 15151 HIGHWAY 5
 EDEN PRAIRIE, MN. 55344, USA

THIS DATA IS A PERFORMANCE PREDICTION BASED ON GENERAL EMPIRICAL FORMULAS FOR THE GIVEN APPLICATION INFORMATION. IT DOES NOT CONSTITUTE APPLICATION APPROVAL OR ASSURANCE OF SIMILAR RESULTS FOR ANY PARTICULAR EQUIPMENT.

DATE: 12/19/1997

TITLE: HARVESTER'S LTD.

PUMP MODEL	MOTOR MODEL	NO. OF MOTORS	RELIEF PRESS(BAR)	CHARGE PRESS(BAR)	CHARGE PUMP LOSS(KW)
4621	4631	1	414.0	11.0	1.20

AVAILABLE TRANSMISSION INPUT POWER 45.00 KW

PUMP PERFORMANCE FOR MODEL 4621

	4.10	3.00	6.00	9.00	12.00	15.00	18.00
SWASH ANGLE (DEG.)	4.10	3.00	6.00	9.00	12.00	15.00	18.00
DISPLACEMENT (CU.CM.)	16.6264	12.1427	24.3522	36.6970	49.2484	62.0825	75.2822
INPUT SPEED (RPM)	3308.	3308.	3308.	3308.	3308.	3308.	3308.
INPUT TORQUE (N.M)	126.4	96.4	126.4	126.4	126.4	126.4	126.4
OUTPUT FLOW (L/MIN)	32.62	17.67	66.59	113.02	156.54	200.02	254.54
INPUT POWER (KW)	43.80	33.39	43.80	43.80	43.80	43.80	43.80
SYS. PRESSURE (BAR)	414.00	414.00	287.02	189.92	141.20	109.41	89.34
VOLUMETRIC EFFICIENCY	59.30	43.99	82.67	93.10	96.09	97.39	98.60
TORSIONAL EFFICIENCY	86.64	83.00	87.98	87.73	87.53	85.50	84.66
OVERALL EFFICIENCY	51.38	36.51	72.73	81.67	84.11	83.27	83.47

MOTOR PERFORMANCE FOR MODEL 4631

	18.00	18.00	18.00	18.00	18.00	18.00	18.00
SWASH ANGLE (DEG.)	18.00	18.00	18.00	18.00	18.00	18.00	18.00
DISPLACEMENT (CU.CM.)	75.2822	75.2822	75.2822	75.2822	75.2822	75.2822	75.2822
OUTPUT SPEED (RPM)	1363.11	172.70	833.30	11466.97	2047.47	2628.41	3235.85
OUTPUT TORQUE (N.M)	471.6	466.6	328.0	215.8	155.9	115.4	88.5
OUTPUT FLOW (L/MIN)	27.34	13.00	62.73	110.44	154.14	197.87	243.60
OUTPUT POWER (KW)	17.93	8.44	28.63	33.15	33.43	31.78	30.00
VOLUMETRIC EFFICIENCY	83.81	73.57	94.20	97.72	98.47	98.93	99.21
TORSIONAL EFFICIENCY	95.08	94.07	95.39	94.83	92.16	88.07	82.70
OVERALL EFFICIENCY	79.68	69.21	89.86	92.66	90.75	87.12	82.05
PUMP&MTR. EFFICIENCY	40.94	25.27	65.36	75.68	76.33	72.55	68.49
HYD.TRAN. EFFICIENCY	39.85	24.39	63.61	73.66	74.29	70.61	66.66

VEHICLE PERFORMANCE

	19430.	19224.	13515.	8890.	6424.	4756.	3647.
TRACTIVE EFFORT (N)	19430.	19224.	13515.	8890.	6424.	4756.	3647.
VEHICLE SPEED (KM/H)	2.99	1.42	6.86	12.08	16.86	21.65	26.65
DRAWBAR PULL (N)	16488.	16282.	10573.	5948..	3482.	1814.	705.
DRAWBAR POWER (KW)	13.70	6.43	20.16	19.96	16.31	10.91	5.22
GRADEABILITY (%)	17.27	16.91	10.86	6.12	3.67	1.92	.87

GEAR RATIO OR FDR= 33.60
 LOAD RADIUS(MM) = 734.00

GEAR EFF.= 90.00
 ROLL RES.COEFF.= .03

VEHICLE WT. (KG) = 10000.
 ROLLING RES. (N) 2942.

Acme Auger Ltd. Calculations

Power Range Calculations

We do not need to calculate the power range because the customer has specified the final drive ratios.

Motor Selection Calculations

$$\begin{aligned}
 T_m &= \frac{T_s}{(FDR)(E_r)} \\
 &= \frac{30000}{(88.6)(.92)} \\
 &= 368 \text{ lb-ft} \\
 &= 368 \times 12 \text{ lb-in/lb-ft} \\
 &= 4417 \text{ lb-in}
 \end{aligned}$$

Max. system pressure = 4500 psi

Therefore use a model 64 MF. The 64 MF has an output torque of 4375 inlb @ 4500 psi.

This should be close enough to meet their specification.

Final Drive Ratio Selection

The final drive ratios are specified by the customer. No calculations are required.

Pump Selection

$$\begin{aligned}
 N_m &= (N_s)(FDR) \\
 &= (25)(88.6) \\
 &= 2215 \text{ rpm} \\
 D_p &= \frac{(N_m)(D_m)}{(N_p)(E_{op})(E_{om})} \\
 D_p &= \frac{(2215)(6.431)}{(2800)(.96)(.97)} \\
 &= 5.463 \text{ in}^3/\text{rev}
 \end{aligned}$$

Overspeed Calculations

Overspeed calculation are unnecessary because their is no possibility of having an overdriving load with an earth auger.

System Pressure at Maximum Pump Displacement

$$\begin{aligned}
 T_p &= \frac{(P_i)(63025)(E_{ir})}{(N_e)(FDR)} \\
 &= \frac{(114)(63025)(1)}{(2800)(1)} \\
 &= 2566 \text{ lb-in}
 \end{aligned}$$

$$\begin{aligned}
 P &= \frac{(T_p)(2\pi)(E_{tp})}{D_p} \\
 &= \frac{(2566)(2\pi)(.95)}{5.439} \\
 &= 2816 \text{ psi} \quad \text{OK.}
 \end{aligned}$$

Heavy Duty Hydrostatic Transmission



Application Data Sheet

Light / Medium / Heavy Duty Hydrostatic Transmission

Eaton Corporation Hydraulics Division 15151 Highway 5 Eden Prairie MN 55344

Date: 21/8/89

Application No. 104A

MPS/EP No.

Company Name ACME AUGER LTD.

Completed By ROGER BENKOVIC

Address

City Phone No.

State Zip Contact

MOBILE APPLICATION

Vehicle Description

Vehicle Weight: Net Gross Max. Weight on Drive Wheels

Vehicle Ground Speed: Working Range MPH

Road Range MPH

Max. Desired Gradeability %; Max. Desired Drawbar or Tractive Effort

Coefficient of Traction (adhesion)

Coefficient of Rolling Resistance

Rolling Radius (include optional tires)

Vehicle Accessories: Trailers Wheel Weights Other (describe)

To Complete See Reverse Side

NON MOBILE APPLICATION

Description of Application

Output Torque Required from Transmission: Continuous 18000 lb ft Maximum 30000 lb ft

Output Speed Required from Transmission: Minimum 5 Maximum 25 rpm

To Complete See Reverse Side

WINCH APPLICATION

Drum Diameter Drum RPM Maximum

Line Pull Required lbs

Line Speed: Feet per Minute Maximum

Cable Diameter Inches Nestled Cable Diameter

Cable Wraps

POWER SOURCE

Gas Diesel Electric Make and Model No. _____

Horsepower Rating (@ Full Loaded Governed Speed) 114 HP @ 2800 RPM

PUMP INPUT

Input Rotation (Facing Input Drive Shaft): CW CCW

Input Drive: Belt Chain Direct/Coupling

Input Drive Ratio 1:1

Normal Input Horsepower 85 Input RPM 2800

Maximum Input Horsepower 114 Input RPM 2800

MOTOR OUTPUT

Output Drive: Belt Chain Direct/Coupling Axle

Multispeed Gear Box Ratios 1st 88.6 2nd 42.8 3rd 28.1 4th 13.6

Axle or Final Drive Ratio _____ Drive Ratio Efficiency 92%

CONTROL INPUT

Hand Lever Foot Pedal Other (describe) Manual Cable

DUTY CYCLE:

Describe Operating Conditions (% time) Unknown. The customer specifies that the system pressure shall not exceed 4,500 psi due to the plumbing design.

EATON CORP.
 HYDRAULICS DIVISION
 15151 HIGHWAY 5
 EDEN PRAIRIE, MN, 55344, USA

THIS DATA IS A PERFORMANCE PREDICTION BASED ON GENERAL EMPIRICAL FORMULAS FOR THE GIVEN APPLICATION INFORMATION. IT DOES NOT CONSTITUTE APPLICATION APPROVAL OR ASSURANCE OF SIMILAR RESULTS FOR ANY PARTICULAR EQUIPMENT.

DATE: 12/19/1997

TITLE: ACME AUGER, LTD. - EARTH AUGER

PUMP MODEL	MOTOR MODEL	NO. OF MOTORS	RELIEF PRESS(PSI)	CHARGE PRESS(PSI)	CHARGE PUMP LOSS(HP)
5421	6431	1	4500.0	160.0	1.50

AVAILABLE TRANSMISSION INPUT POWER 114.00 HP

PUMP PERFORMANCE FOR MODEL 5421

	11.12	3.00	6.00	9.00	12.00	15.00	18.00
SWASH ANGLE (DEG.)	11.12	3.00	6.00	9.00	12.00	15.00	18.00
DISPLACEMENT (CU.IN.)	3.2897	.8773	1.7594	2.6513	3.5581	4.4853	5.4390
INPUT SPEED (RPM)	2000.	2800.	2800.	2800.	2800.	2800.	2800.
INPUT TORQUE (LBF.IN.)	2532.25	774.96	1411.04	2061.66	2532.25	2532.25	2532.25
OUTPUT FLOW (GPM)	36.16	6.79	17.52	28.17	39.77	51.43	63.86
INPUT POWER (HP)	12.50	34.43	62.69	91.59	112.50	112.50	112.50
SYS. PRESSURE (PSI)	4500.00	4500.00	4500.00	4500.00	4159.54	3265.77	2703.35
VOLUMETRIC EFFICIENCY	90.68	63.84	82.14	87.65	92.22	94.59	96.86
TORSIONAL EFFICIENCY	93.04	81.08	89.30	92.10	93.02	92.06	92.41
OVERALL EFFICIENCY	84.37	51.76	73.35	80.73	85.79	87.08	89.51

MOTOR PERFORMANCE FOR MODEL 6431

	18.00	18.00	18.00	18.00	18.00	18.00	18.00
SWASH ANGLE (DEG.)	18.00	18.00	18.00	18.00	18.00	18.00	18.00
DISPLACEMENT (CU.IN.)	6.4350	6.4350	6.4350	6.4350	6.4350	6.4350	6.4350
OUTPUT SPEED (RPM)	1226.90	204.17	577.74	948.60	1361.21	1793.34	2244.63
OUTPUT TORQUE(LBF.IN.)	4407.11	4311.08	4387.47	4407.74	4062.69	3156.49	2562.56
OUTPUT FLOW (GPM)	34.18	5.69	16.09	26.43	37.92	49.96	62.53
OUTPUT POWER (HP)	85.79	13.97	40.22	66.34	87.75	89.82	91.27
VOLUMETRIC EFFICIENCY	94.52	83.79	91.88	93.82	95.34	97.14	97.92
TORSIONAL EFFICIENCY	95.63	93.54	95.20	95.64	95.37	94.37	92.56
OVERALL EFFICIENCY	90.38	78.37	87.47	89.72	90.92	91.68	90.63
PUMP&MTR. EFFICIENCY	76.26	40.56	64.16	72.43	78.00	79.84	81.12
HYD.TRAN. EFFICIENCY	75.26	38.87	62.66	71.26	76.97	78.79	80.06

AUGER PERFORMANCE

OUTPUT TORQUE(LBF.FT.)	4495.	4492.	4572.	4593.	4233.	3289.	2670.
OUTPUT SPEED (RPM)	90.3	15.0	42.5	69.8	100.2	131.9	165.1

GEAR RATIO = 13.60

GEAR EFFICIENCY = 92.00

EATON CORP.
 HYDRAULICS DIVISION
 15151 HIGHWAY 5
 EDEN PRAIRIE, MN, 55344, USA

THIS DATA IS A PERFORMANCE PREDICTION BASED ON GENERAL EMPIRICAL FORMULAS FOR THE GIVEN APPLICATION INFORMATION. IT DOES NOT CONSTITUTE APPLICATION APPROVAL OR ASSURANCE OF SIMILAR RESULTS FOR ANY PARTICULAR EQUIPMENT.

DATE: 12/19/1997

TITLE: ACME AUGER, LTD. - EARTH AUGER

PUMP MODEL	MOTOR MODEL	NO. OF MOTORS	RELIEF PRESS(PSI)	CHARGE PRESS(PSI)	CHARGE PUMP LOSS(HP)
5421	6431	1	4500.0	160.0	1.50

AVAILABLE TRANSMISSION INPUT POWER 114.00 HP

PUMP PERFORMANCE FOR MODEL 5421

	11.12	3.00	6.00	9.00	12.00	15.00	18.00
SWASH ANGLE (DEG.)	11.12	3.00	6.00	9.00	12.00	15.00	18.00
DISPLACEMENT (CU.IN.)	3.2897	.8773	1.7594	2.6513	3.5581	4.4853	5.4390
INPUT SPEED (RPM)	2000.	2800.	2800.	2800.	2800.	2800.	2800.
INPUT TORQUE (LBF.IN.)	2532.25	774.96	1411.04	2061.66	2532.25	2532.25	2532.25
OUTPUT FLOW (GPM)	36.16	6.79	17.52	28.17	39.77	51.43	63.86
INPUT POWER (HP)	12.50	34.43	62.69	91.59	112.50	112.50	112.50
SYS. PRESSURE (PSI)	4500.00	4500.00	4500.00	4500.00	4159.54	3265.77	2703.35
VOLUMETRIC EFFICIENCY	90.68	63.84	82.14	87.65	92.22	94.59	96.86
TORSIONAL EFFICIENCY	93.04	81.08	89.30	92.10	93.02	92.06	92.41
OVERALL EFFICIENCY	84.37	51.76	73.35	80.73	85.79	87.08	89.51

MOTOR PERFORMANCE FOR MODEL 6431

	18.00	18.00	18.00	18.00	18.00	18.00	18.00
SWASH ANGLE (DEG.)	18.00	18.00	18.00	18.00	18.00	18.00	18.00
DISPLACEMENT (CU.IN.)	6.4350	6.4350	6.4350	6.4350	6.4350	6.4350	6.4350
OUTPUT SPEED (RPM)	1226.90	204.17	577.74	948.60	1361.21	1793.34	2244.63
OUTPUT TORQUE(LBF.IN.)	4407.11	4311.08	4387.47	4407.74	4062.69	3156.49	2562.56
OUTPUT FLOW (GPM)	34.18	5.69	16.09	26.43	37.92	49.96	62.53
OUTPUT POWER (HP)	85.79	13.97	40.22	66.34	87.75	89.82	91.27
VOLUMETRIC EFFICIENCY	94.52	83.79	91.88	93.82	95.34	97.14	97.92
TORSIONAL EFFICIENCY	95.63	93.54	95.20	95.64	95.37	94.37	92.56
OVERALL EFFICIENCY	90.38	78.37	87.47	89.72	90.92	91.68	90.63
PUMP&MTR. EFFICIENCY	76.26	40.56	64.16	72.43	78.00	79.84	81.12
HYD.TRAN. EFFICIENCY	75.26	38.87	62.66	71.26	76.97	78.79	80.06

AUGER PERFORMANCE

	9488.	9282.	9446.	9490.	8747.	6796.	55.17
OUTPUT TORQUE(LBF.FT.)	9488.	9282.	9446.	9490.	8747.	6796.	55.17
OUTPUT SPEED (RPM)	43.7	7.3	20.6	33.8	48.5	63.9	79.9

GEAR RATIO = 28.10

GEAR EFFICIENCY = 92.00

EATON CORP.
 HYDRAULICS DIVISION
 15151 HIGHWAY 5
 EDEN PRAIRIE, MN, 55344, USA

THIS DATA IS A PERFORMANCE PREDICTION BASED ON GENERAL EMPIRICAL FORMULAS FOR THE GIVEN APPLICATION INFORMATION. IT DOES NOT CONSTITUTE APPLICATION APPROVAL OR ASSURANCE OF SIMILAR RESULTS FOR ANY PARTICULAR EQUIPMENT.

DATE: 12/19/1997

TITLE: ACME AUGER, LTD. - EARTH AUGER

PUMP MODEL	MOTOR MODEL	NO. OF MOTORS	RELIEF PRESS(PSI)	CHARGE PRESS(PSI)	CHARGE PUMP LOSS(HP)
5421	6431	1	4500.0	160.0	1.50

AVAILABLE TRANSMISSION INPUT POWER 114.00 HP

PUMP PERFORMANCE FOR MODEL 5421

	11.12	3.00	6.00	9.00	12.00	15.00	18.00
SWASH ANGLE (DEG.)	11.12	3.00	6.00	9.00	12.00	15.00	18.00
DISPLACEMENT (CU.IN.)	3.2897	.8773	1.7594	2.6513	3.5581	4.4853	5.4390
INPUT SPEED (RPM)	2000.	2800.	2800.	2800.	2800.	2800.	2800.
INPUT TORQUE (LBF.IN.)	2532.25	774.96	1411.04	2061.66	2532.25	2532.25	2532.25
OUTPUT FLOW (GPM)	36.16	6.79	17.52	28.17	39.77	51.43	63.86
INPUT POWER (HP)	12.50	34.43	62.69	91.59	112.50	112.50	112.50
SYS. PRESSURE (PSI)	4500.00	4500.00	4500.00	4500.00	4159.54	3265.77	2703.35
VOLUMETRIC EFFICIENCY	90.68	63.84	82.14	87.65	92.22	94.59	96.86
TORSIONAL EFFICIENCY	93.04	81.08	89.30	92.10	93.02	92.06	92.41
OVERALL EFFICIENCY	84.37	51.76	73.35	80.73	85.79	87.08	89.51

MOTOR PERFORMANCE FOR MODEL 6431

	18.00	18.00	18.00	18.00	18.00	18.00	18.00
SWASH ANGLE (DEG.)	18.00	18.00	18.00	18.00	18.00	18.00	18.00
DISPLACEMENT (CU.IN.)	6.4350	6.4350	6.4350	6.4350	6.4350	6.4350	6.4350
OUTPUT SPEED (RPM)	1226.90	204.17	577.74	948.60	1361.21	1793.34	2244.63
OUTPUT TORQUE(LBF.IN.)	4407.11	4311.08	4387.47	4407.74	4062.69	3156.49	2562.56
OUTPUT FLOW (GPM)	34.18	5.69	16.09	26.43	37.92	49.96	62.53
OUTPUT POWER (HP)	85.79	13.97	40.22	66.34	87.75	89.82	91.27
VOLUMETRIC EFFICIENCY	94.52	83.79	91.88	93.82	95.34	97.14	97.92
TORSIONAL EFFICIENCY	95.63	93.54	95.20	95.64	95.37	94.37	92.56
OVERALL EFFICIENCY	90.38	78.37	87.47	89.72	90.92	91.68	90.63
PUMP&MTR. EFFICIENCY	76.26	40.56	64.16	72.43	78.00	79.84	81.12
HYD.TRAN. EFFICIENCY	75.26	38.87	62.66	71.26	76.97	78.79	80.06

AUGER PERFORMANCE

OUTPUT TORQUE(LBF.FT.)	14486.	14170.	14422.	14488.	13354.	10375.	8423.
OUTPUT SPEED (RPM)	28.6	4.8	13.5	22.1	31.7	41.8	52.4

GEAR RATIO = 42.90

GEAR EFFICIENCY = 92.00

EATON CORP.
 HYDRAULICS DIVISION
 15151 HIGHWAY 5
 EDEN PRAIRIE, MN, 55344, USA

THIS DATA IS A PERFORMANCE PREDICTION BASED ON GENERAL EMPIRICAL FORMULAS FOR THE GIVEN APPLICATION INFORMATION. IT DOES NOT CONSTITUTE APPLICATION APPROVAL OR ASSURANCE OF SIMILAR RESULTS FOR ANY PARTICULAR EQUIPMENT.

DATE: 12/19/1997

TITLE: ACME AUGER, LTD. - EARTH AUGER

PUMP MODEL	MOTOR MODEL	NO. OF MOTORS	RELIEF PRESS(PSI)	CHARGE PRESS(PSI)	CHARGE PUMP LOSS(HP)
5421	6431	1	4500.0	160.0	1.50

AVAILABLE TRANSMISSION INPUT POWER 114.00 HP

PUMP PERFORMANCE FOR MODEL 5421

	11.12	3.00	6.00	9.00	12.00	15.00	18.00
SWASH ANGLE (DEG.)	11.12	3.00	6.00	9.00	12.00	15.00	18.00
DISPLACEMENT (CU.IN.)	3.2897	.8773	1.7594	2.6513	3.5581	4.4853	5.4390
INPUT SPEED (RPM)	2000.	2800.	2800.	2800.	2800.	2800.	2800.
INPUT TORQUE (LBF.IN.)	2532.25	774.96	1411.04	2061.66	2532.25	2532.25	2532.25
OUTPUT FLOW (GPM)	36.16	6.79	17.52	28.17	39.77	51.43	63.86
INPUT POWER (HP)	12.50	34.43	62.69	91.59	112.50	112.50	112.50
SYS. PRESSURE (PSI)	4500.00	4500.00	4500.00	4500.00	4159.54	3265.77	2703.35
VOLUMETRIC EFFICIENCY	90.68	63.84	82.14	87.65	92.22	94.59	96.86
TORSIONAL EFFICIENCY	93.04	81.08	89.30	92.10	93.02	92.06	92.41
OVERALL EFFICIENCY	84.37	51.76	73.35	80.73	85.79	87.08	89.51

MOTOR PERFORMANCE FOR MODEL 6431

	18.00	18.00	18.00	18.00	18.00	18.00	18.00
SWASH ANGLE (DEG.)	18.00	18.00	18.00	18.00	18.00	18.00	18.00
DISPLACEMENT (CU.IN.)	6.4350	6.4350	6.4350	6.4350	6.4350	6.4350	6.4350
OUTPUT SPEED (RPM)	1226.90	204.17	577.74	948.60	1361.21	1793.34	2244.63
OUTPUT TORQUE(LBF.IN.)	4407.11	4311.08	4387.47	4407.74	4062.69	3156.49	2562.56
OUTPUT FLOW (GPM)	34.18	5.69	16.09	26.43	37.92	49.96	62.53
OUTPUT POWER (HP)	85.79	13.97	40.22	66.34	87.75	89.82	91.27
VOLUMETRIC EFFICIENCY	94.52	83.79	91.88	93.82	95.34	97.14	97.92
TORSIONAL EFFICIENCY	95.63	93.54	95.20	95.64	95.37	94.37	92.56
OVERALL EFFICIENCY	90.38	78.37	87.47	89.72	90.92	91.68	90.63
PUMP&MTR. EFFICIENCY	76.26	40.56	64.16	72.43	78.00	79.84	81.12
HYD.TRAN. EFFICIENCY	75.26	38.87	62.66	71.26	76.97	78.79	80.06

AUGER PERFORMANCE

OUTPUT TORQUE(LBF.FT.)	29917.	29266.	29784.	29922.	27579.	21427.	17395.
OUTPUT SPEED (RPM)	13.9	2.3	6.5	10.7	15.4	20.3	25.4

GEAR RATIO = 88.60

GEAR EFFICIENCY = 92.00

Notes:

Common Used Conversions

To Convert	Into	Multiply by
bar	psi	14.5
cm ³	in ³	0.06102
°C	°F	(°C x 1.8)+32
gallons (US)	liters	3.785
kg	lbs	2.205
kgf/cm ²	psi	14.2
kW	hp	1.341
liters	US gallons	0.2642
mm	inches	0.03937
N-m	lb-in	8.85
N-m	lb-ft	0.7375
°F	°C	(°F-32)/1.8
hp	kW	0.7457
inch	mm	25.4
in ³	cm ³	16.39
lb-in	N-m	0.113
lb-ft	N-m	1.356
lbs	kg	0.4535
psi	bar	0.06896
psi	kgf/cm ²	.070307

Basic Formulas...

...For Hydraulic Pumps

OUTPUT FLOW

$$\text{lpm} = \frac{\text{cm}^3/\text{r} \times \text{rpm}}{1000} \quad \text{gpm} = \frac{\text{in}^3/\text{r} \times \text{rpm}}{231}$$

INPUT POWER

$$\text{kW} = \frac{\text{l/min} \times \text{bar}}{600} \quad \text{hp} = \frac{\text{gpm} \times \text{psi}}{1714}$$

...For Hydraulic Motors

SHAFT TORQUE

$$\text{N-m} = \frac{\text{bar} \times \text{cm}^3/\text{r}}{62.8} \quad \text{lb-in} = \frac{\text{psi} \times \text{in}^3/\text{r}}{6.28}$$

SHAFT SPEED

$$\text{rpm} = \frac{1000 \times \text{l/min}}{\text{cm}^3/\text{r}} \quad \text{RPM} = \frac{231 \times \text{gpm}}{\text{in}^3/\text{r}}$$

OUTPUT POWER

$$\text{kW} = \frac{\text{N-m} \times \text{RPM}}{9549} \quad \text{hp} = \frac{\text{lb-in} \times \text{rpm}}{63,025}$$

...For Hydraulic Cylinders

AREA = DIAMETER² X .7854

FORCE = PRESSURE X AREA

SPEED

$$\text{meters per minute} = \frac{\text{l/min} \times 10}{\text{area cm}^2} \quad \text{feet per minute} = \frac{\text{gpm} \times 19.25}{\text{area in}^2}$$

bar = 10 Newtons /cm²
 gpm = gallons per minute
 hp = horsepower
 lb-in = pound inch
 lb-ft = pound feet
 kW = kilowatt
 kgf = kilograms force
 l/min = liters per minute
 N-m = Newton meters
 psi = pounds per square inch
 rpm = revolutions per minute

Eaton Corporation
Hydraulics Division
15151 Hwy. 5
Eden Prairie, MN 55344
Telephone 612/937-9800
Fax 612/937-7130

Eaton Ltd.
Hydraulics Division
Glenrothes, Fife
Scotland, KY7 4NW
Telephone 01-592-771-771
Fax 01-592-773-184

Eaton GmbH
Hydraulics Products
Am Schimmersfeld 7
40880 Ratingen, Germany
Telephone 02102-406-830
Fax 02102-406-800



Quality System Certified
Products in this catalog are manufactured
in an ISO-9001-certified site.